



# Zebra Healthcare Supplies Catalog



SEE MORE. DO MORE.



Zebra has the right labels for hospital applications. Genuine Zebra® labels are available in a range of sizes, materials and adhesives that can withstand all types of testing and storage requirements. Our labels are suitable for labeling all shapes and sizes of specimen containers, including test tubes, vials, microscope slides, petri dishes, and cassettes—plus pharmacy unit dose containers, including syringes and IV bags. Zebra even offers special blood bag labels that meet ISBT 128 compliance requirements.

Effective January 2015



SEE MORE.  
DO MORE.

# Table of Contents

## Healthcare Price List

### Lab

|                        |   |
|------------------------|---|
| MISYS/Sunquest .....   | 3 |
| Microscope Slide ..... | 4 |
| General .....          | 5 |

|                              |   |
|------------------------------|---|
| <b><u>ISBT 128</u></b> ..... | 7 |
|------------------------------|---|

### **Mobile Specimen Collection**

|                                |    |
|--------------------------------|----|
| Cerner, McKesson, Siemens..... | 8  |
| Cerner Aliquot Label .....     | 9  |
| Meditech .....                 | 10 |
| Meditech Aliquot Label .....   | 11 |
| IQ Color.....                  | 12 |

|                              |    |
|------------------------------|----|
| <b><u>Pharmacy</u></b> ..... | 13 |
|------------------------------|----|

### **Breast Milk Tracking**

|                                |    |
|--------------------------------|----|
| Cerner, McKesson, Siemens..... | 14 |
| Meditech .....                 | 15 |
| CareFusion .....               | 16 |

|                                  |    |
|----------------------------------|----|
| <b><u>Multipurpose</u></b> ..... | 17 |
|----------------------------------|----|

### **Specialty**

|                      |    |
|----------------------|----|
| Radiology .....      | 20 |
| Sterilization .....  | 21 |
| Asset Tracking ..... | 22 |

### **Wristbanding**

|  |    |
|--|----|
| HC100 Wristband Cartridges.....                              | 23 |
| Wristbands for Desktop and Industrial/Tabletop Printers..... | 28 |

### **Wristbanding – Non-Printable**

|  |    |
|--|----|
| Alert Solutions.....                   | 35 |
| OmniBand.....                          | 38 |
| Vinyl Infant Wristband Solutions ..... | 39 |
| ComfyCuff Solution .....               | 40 |

|                             |    |
|-----------------------------|----|
| <b><u>Ribbons</u></b> ..... | 42 |
|-----------------------------|----|



SEE MORE.  
DO MORE.

## Catalog Updates

### ***New Items***

#### **Mobile Specimen Collection: IQ Color**

**IQ Color 2000D (p. 12)**

10020397

#### **Wristbanding**

**Z-Band Fusion Infant ID Tags (p. 32)**

FID-BABY-T-1-500, FID-BABY-T-3-1M

#### **Wristbanding: Non-Printable**

**Vinyl Infant Wristband Solutions (p. 39)**

PS-BABY, PS-INFANT-ADJ

**ComfyCuff Solution (p. 46)**

LB2-BABY-P, LB2-BABY-CCS, LB2-BABY-SWB9

### ***Discontinued Items***

#### **Breast Milk Tracking: Meditech**

**PolyPro 4000D**

10017581, 10017582



SEE MORE.  
DO MORE.

# Lab

## MISYS/Sunquest

### 8000D Lab

A direct thermal paper label with a permanent acrylic adhesive specifically designed to adhere to small, curved surfaces.

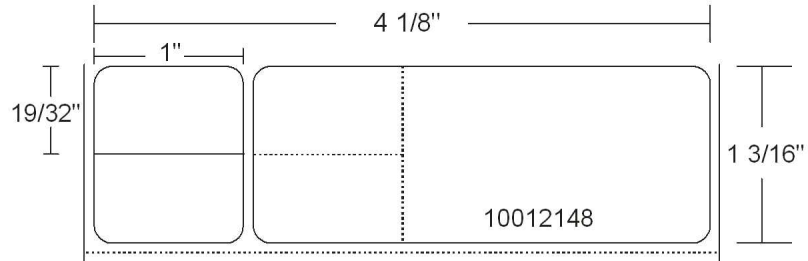

| Size (inches)    | PartNumber | ID | OD | Stock | MTO | Carton Weight | Color | Quantity Per Roll | Rolls Per Carton |
|------------------|------------|----|----|-------|-----|---------------|-------|-------------------|------------------|
| 4.125" x 1.1875" | 10012148   | 1" | 5" | Stock |     | 20 lbs.       | White | 2,000             | 4                |

Stock - ships within one business day, Made to order - ships within 6 business days.  
Prices effective January 2015 - All prices subject to change without notice.

Need a custom solution? Call for a quote today: +1 866 230 9495



SEE MORE.  
DO MORE.

# Lab

## Microscope Slide

### PolyPro 4000T

A thermal transfer Kimdura® polypropylene label with a permanent acrylic adhesive.

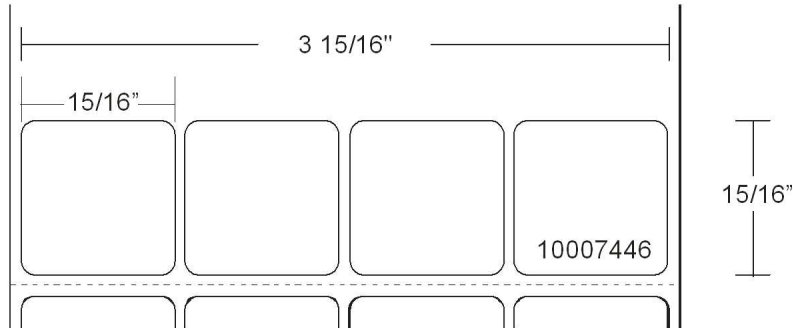

| Size (inches)     | PartNumber | ID | OD | Quantity Per Roll | Rolls Per Carton | Carton Weight | Stock MTO | Ribbon       |
|-------------------|------------|----|----|-------------------|------------------|---------------|-----------|--------------|
| 0.9375" x 0.9375" | 10007446   | 1" | 5" | 1,900             | 6                | 10 lbs.       | Stock     | 06100GS06407 |

### Z-Xtreme 5000T

A thermal transfer, coated label with a high performance acrylic adhesive that will stay put on difficult-to-label surfaces.

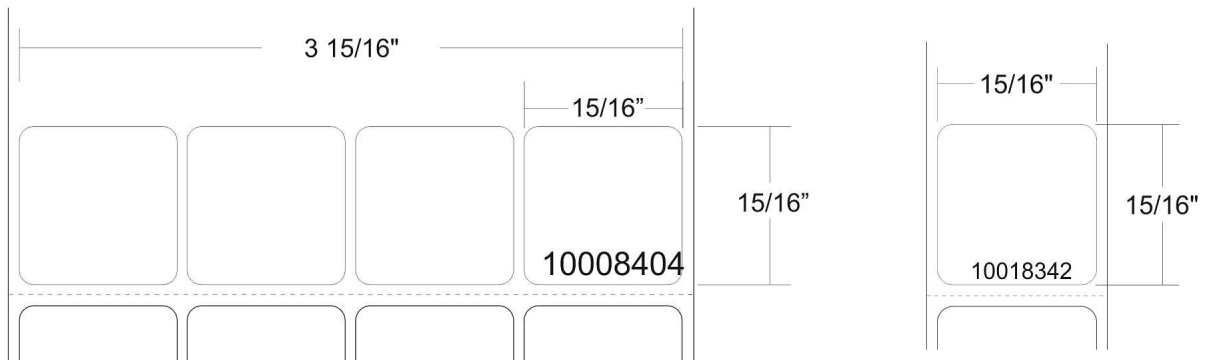

| Size (inches)     | PartNumber | ID | OD | Quantity Per Roll | Rolls Per Carton | Carton Weight | Stock MTO | Ribbon |
|-------------------|------------|----|----|-------------------|------------------|---------------|-----------|--------|
| 0.9375" x 0.9375" | 10008404   | 1" | 5" | 2,190             | 4                | 6 lbs.        | Stock     | 74943  |
| 0.9375" x 0.9375" | 10018342   | 1" | 5" | 2,195             | 4                | 4 lbs.        | MTO       | 74941  |

Stock - ships within one business day, Made to order - ships within 6 business days.  
Prices effective January 2015 - All prices subject to change without notice.

Need a custom solution? Call for a quote today: +1 866 230 9495



SEE MORE.  
DO MORE.

# Lab

## General

### 8000D Lab

A direct thermal paper label with a high-tack permanent acrylic adhesive specifically designed to adhere to small, curved surfaces.

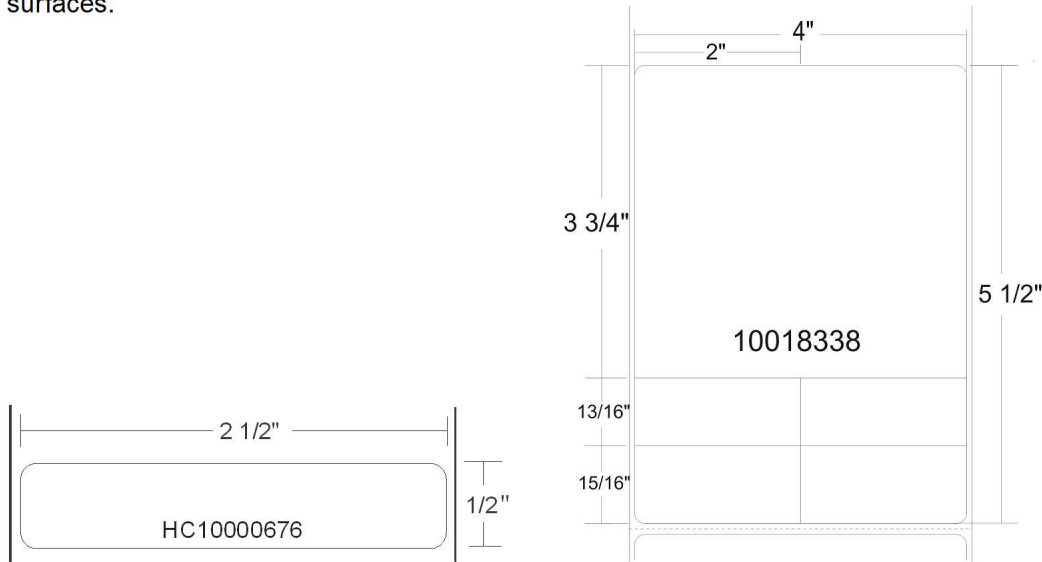

| Size (inches) | PartNumber | ID | OD | Color | Quantity Per Roll | Rolls Per Carton | Carton Weight | Stock MTO |
|---------------|------------|----|----|-------|-------------------|------------------|---------------|-----------|
| 2.5" x 0.5"   | HC10000676 | 3" | 8" | White | 9,220             | 6                | 30 lbs.       | MTO       |
| 4" x 5.5"     | 10018338   | 3" | 8" | White | 1,050             | 4                | 26 lbs.       | Stock     |

### PolyPro 4000D

A direct thermal polypropylene label with an all-temp permanent acrylic adhesive.

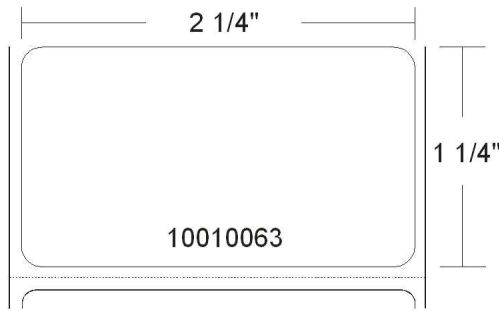

| Size (inches) | PartNumber | ID | OD | Quantity Per Roll | Rolls Per Carton | Carton Weight | Stock MTO |
|---------------|------------|----|----|-------------------|------------------|---------------|-----------|
| 2.25" x 1.25" | 10010063   | 1" | 5" | 2,000             | 6                | 12 lbs.       | Stock     |

Stock - ships within one business day, Made to order - ships within 6 business days.  
Prices effective January 2015 - All prices subject to change without notice.

Need a custom solution? Call for a quote today: +1 866 230 9495



SEE MORE.  
DO MORE.

# Lab

## General

### PolyPro 4000T

A thermal transfer Kimdura® polypropylene label with a permanent acrylic adhesive.

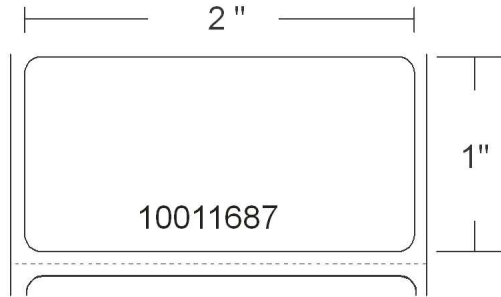

| Size (inches) | PartNumber | ID | OD | Quantity Per Roll | Rolls Per Carton | Carton Weight | Stock MTO | Ribbon       |
|---------------|------------|----|----|-------------------|------------------|---------------|-----------|--------------|
| 2" x 1"       | 10014716   | 3" | 8" | 3,940             | 4                | 10 lbs.       | Stock     | 06100BK06045 |

Stock - ships within one business day, Made to order - ships within 6 business days.  
Prices effective January 2015 - All prices subject to change without notice.

Need a custom solution? Call for a quote today: +1 866 230 9495





SEE MORE.  
DO MORE.

# ISBT 128

## General

### 8000T Primary Blood Bag Label

A thermal transfer polypropylene label with a permanent acrylic adhesive for direct application to a blood bag.

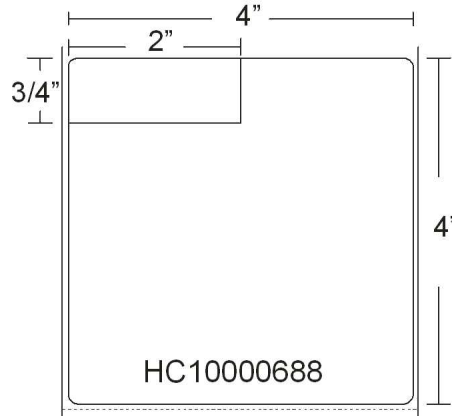

| Size (inches) | PartNumber | ID | OD | Quantity Per Roll | Rolls Per Carton | Carton Weight | Stock MTO | Ribbon       |
|---------------|------------|----|----|-------------------|------------------|---------------|-----------|--------------|
| 4" x 4"       | HC10000688 | 3" | 8" | 1,110             | 4                | 24 lbs.       | Stock     | 06100BK11045 |

Stock - ships within one business day, Made to order - ships within 6 business days.  
Prices effective January 2015 - All prices subject to change without notice.

Need a custom solution? Call for a quote today: +1 866 230 9495





SEE MORE.  
DO MORE.

# Mobile Specimen Collection

Cerner, McKesson, Siemens

## 8000D Lab

A direct thermal paper label with a permanent acrylic adhesive specifically designed to adhere to small, curved surfaces.

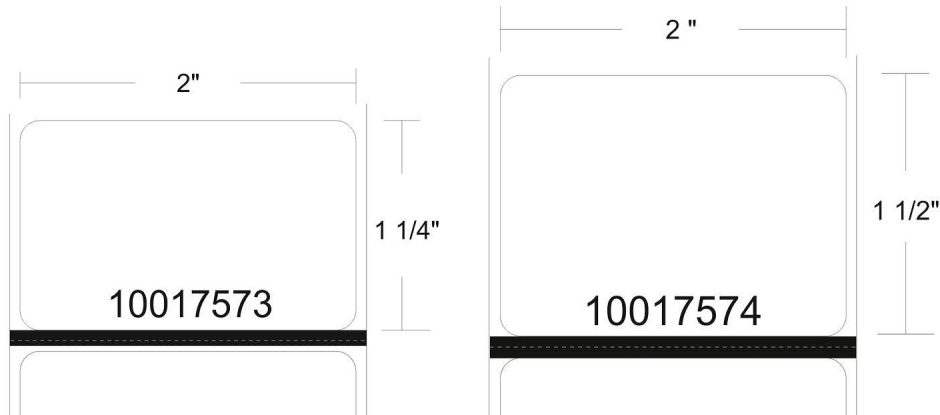

| Size (inches) | PartNumber | ID    | OD   | Quantity Per Roll | Rolls Per Carton | Carton Weight | Stock MTO |
|---------------|------------|-------|------|-------------------|------------------|---------------|-----------|
| 2" x 1.25"    | 10017573   | 0.75" | 2.2" | 330               | 12               | 3 lbs.        | Stock     |
| 2" x 1.5"     | 10017574   | 0.75" | 2.2" | 280               | 12               | 3 lbs.        | Stock     |

## PolyPro 4000D

A direct thermal polypropylene label with an all-temp permanent acrylic adhesive.

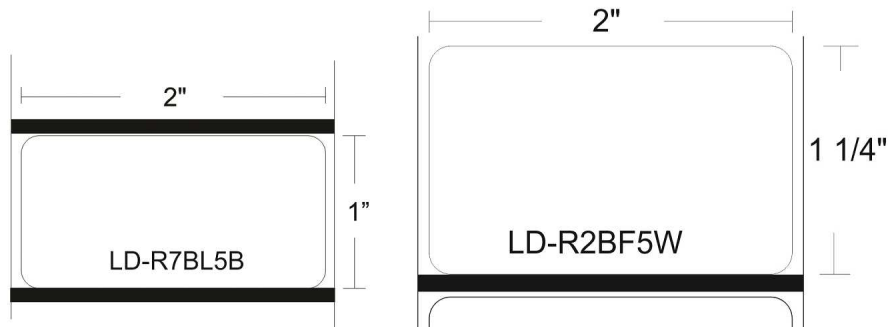

| Size (inches) | PartNumber | ID    | OD | Quantity Per Roll | Rolls Per Carton | Carton Weight | Stock MTO |
|---------------|------------|-------|----|-------------------|------------------|---------------|-----------|
| 2" x 1"       | LD-R7BL5B  | 0.75" | 2" | 350               | 36               | 7 lbs.        | Stock     |
| 2" x 1.25"    | LD-R2BF5W  | 0.75" | 2" | 280               | 36               | 8 lbs.        | Stock     |

Stock - ships within one business day, Made to order - ships within 6 business days.  
Prices effective January 2015 - All prices subject to change without notice.

Need a custom solution? Call for a quote today: +1 866 230 9495



SEE MORE.  
DO MORE.

# Mobile Specimen Collection

## Cerner Aliquot Label

### 8000D Lab

A direct thermal paper label with a permanent acrylic adhesive specifically designed to adhere to small, curved surfaces.

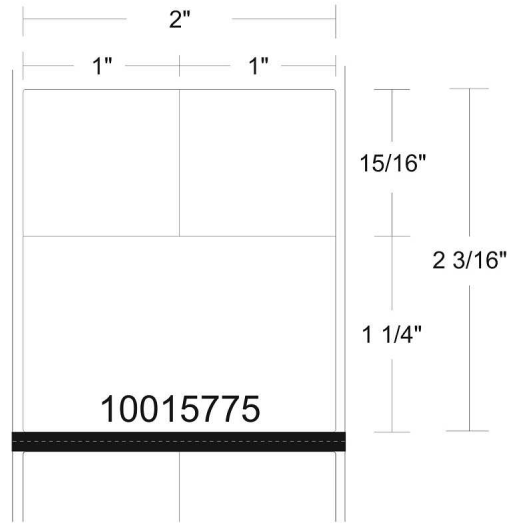

| Size (inches) | PartNumber | ID    | OD   | Quantity Per Roll | Rolls Per Carton | Carton Weight | Stock MTO |
|---------------|------------|-------|------|-------------------|------------------|---------------|-----------|
| 2" x 2.1875"  | 10015775   | 0.75" | 2.2" | 200               | 12               | 5 lbs.        | Stock     |

Stock - ships within one business day, Made to order - ships within 6 business days.  
Prices effective January 2015 - All prices subject to change without notice.

Need a custom solution? Call for a quote today: +1 866 230 9495



SEE MORE.  
DO MORE.

# Mobile Specimen Collection

## Meditech

### 8000D Lab

A direct thermal paper label with a permanent acrylic adhesive specifically designed to adhere to small, curved surfaces.

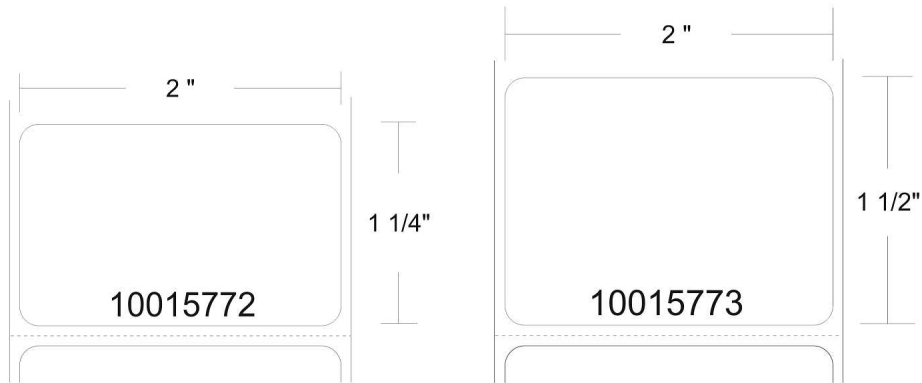

| Size (inches) | PartNumber | ID    | OD   | Quantity Per Roll | Rolls Per Carton | Carton Weight | Stock MTO |
|---------------|------------|-------|------|-------------------|------------------|---------------|-----------|
| 2" x 1.25"    | 10015772   | 0.75" | 2.2" | 330               | 12               | 3 lbs.        | Stock     |
| 2" x 1.5"     | 10015773   | 0.75" | 2.2" | 280               | 12               | 3 lbs.        | Stock     |

### PolyPro 4000D

A direct thermal polypropylene label with an all-temp permanent acrylic adhesive.

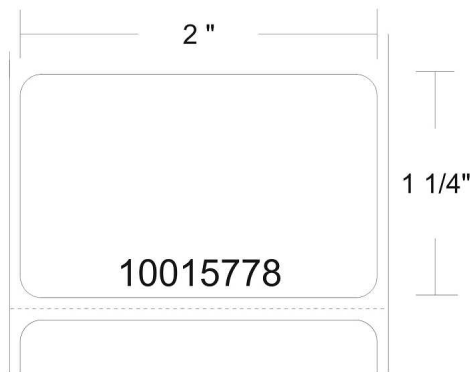

| Size (inches) | PartNumber | ID    | OD   | Quantity Per Roll | Rolls Per Carton | Carton Weight | Stock MTO |
|---------------|------------|-------|------|-------------------|------------------|---------------|-----------|
| 2" x 1.25"    | 10015778   | 0.75" | 2.2" | 380               | 12               | 3 lbs.        | Stock     |

Stock - ships within one business day, Made to order - ships within 6 business days.  
Prices effective January 2015 - All prices subject to change without notice.

Need a custom solution? Call for a quote today: +1 866 230 9495



SEE MORE.  
DO MORE.

# Mobile Specimen Collection

## Meditech Aliquot Label

### 8000D Lab

A direct thermal paper label with a permanent acrylic adhesive specifically designed to adhere to small, curved surfaces.

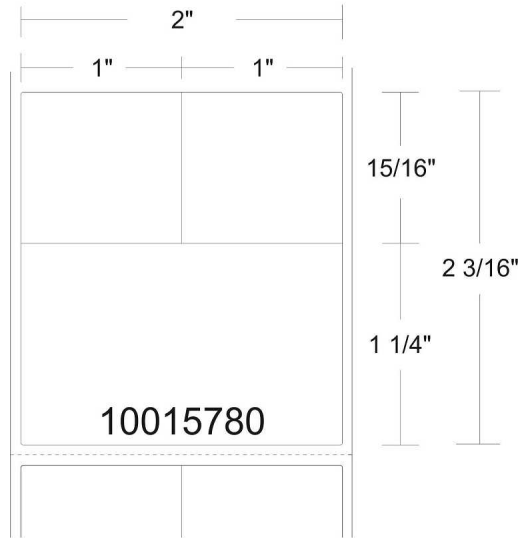

| Size (inches) | PartNumber | ID    | OD   | Quantity Per Roll | Rolls Per Carton | Carton Weight | Stock MTO |
|---------------|------------|-------|------|-------------------|------------------|---------------|-----------|
| 2" x 2.1875"  | 10015780   | 0.75" | 2.2" | 200               | 12               | 3 lbs.        | Stock     |

Stock - ships within one business day, Made to order - ships within 6 business days.  
Prices effective January 2015 - All prices subject to change without notice.

Need a custom solution? Call for a quote today: +1 866 230 9495



SEE MORE.  
DO MORE.

# Mobile Specimen Collection

## IQ Color Specimen Collection Label

### IQ Color 2000D

A white, coated direct thermal paper label with a permanent acrylic adhesive which allows the ability to print vibrant color on-demand in pre-defined zones to be used as a visual cue.



| Size (inches) | PartNumber | ID    | OD   | Quantity Per Roll | Rolls Per Carton | Carton Weight | Stock MTO |
|---------------|------------|-------|------|-------------------|------------------|---------------|-----------|
| 2" x 1"       | 10020397   | 0.75" | 2.2" | 450               | 36               | 18 lbs.       | Stock     |

Red color zone runs along the left edge of the label and measures 0.25" wide x 1" long.  
Black mark sensing and perforations between labels.

*Stock - ships within one business day, Made to order - ships within 6 business days.  
Prices effective January 2015 - All prices subject to change without notice.*

Need a custom solution? Call for a quote today: +1 866 230 9495



SEE MORE.  
DO MORE.

# Pharmacy

## General

### Z-Select 4000D

A direct thermal, bright white coated paper label with an all-temp permanent acrylic adhesive.

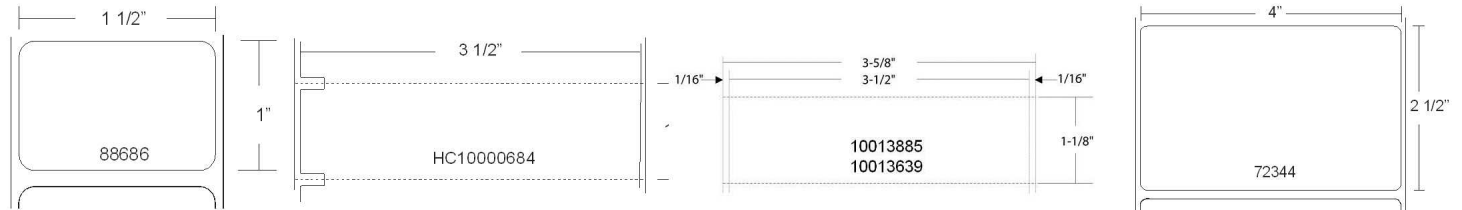

| Size (inches) | PartNumber  | ID | OD | Quantity Per Roll | Rolls Per Carton | Carton Weight | Stock MTO |
|---------------|-------------|----|----|-------------------|------------------|---------------|-----------|
| 1.5" x 1"     | 88686       | 3" | 8" | 5,120             | 14               | 29 lbs.       | Stock     |
| 3.5" x 1"     | HC10000684* | 3" | 8" | 5,760             | 6                | 30 lbs.       | Stock     |
| 3.5" x 1.125" | 10013639    | 3" | 8" | 5,219             | 6                | 30 lbs.       | MTO       |
| 3.5" x 1.125" | 10013885    | 1" | 5" | 2,374             | 4                | 10 lbs.       | MTO       |
| 4" x 2.5"     | 72344       | 3" | 8" | 2,220             | 4                | 24 lbs.       | Stock     |

\*This label has notches on the left side. Printable area is 3.5" x 0.875".

### Z-Select 4000T

A premium, thermal transfer, bright white, coated, ultra-smooth paper label with a permanent acrylic adhesive.

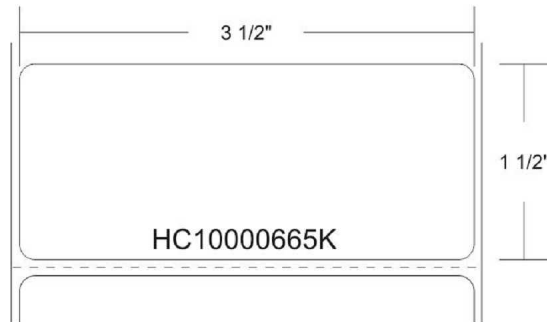

| Size (inches) | PartNumber   | ID | OD | Quantity Per Roll | Rolls Per Carton | Carton Weight | Stock MTO |
|---------------|--------------|----|----|-------------------|------------------|---------------|-----------|
| 3.5" x 1.5"   | HC10000665K* | 1" | 5" | 1,570             | 3                | 15 lbs.       | Stock     |

\*Kit includes 3 rolls of labels and 3 rolls of ribbon part number 05319GS11007. Perforations between labels.



SEE MORE.  
DO MORE.

# Breast Milk Tracking

Cerner, McKesson, Siemens

## PolyPro 4000D

A direct thermal polypropylene label with an all-temp permanent acrylic adhesive. For use in water temperatures up to 160°F.

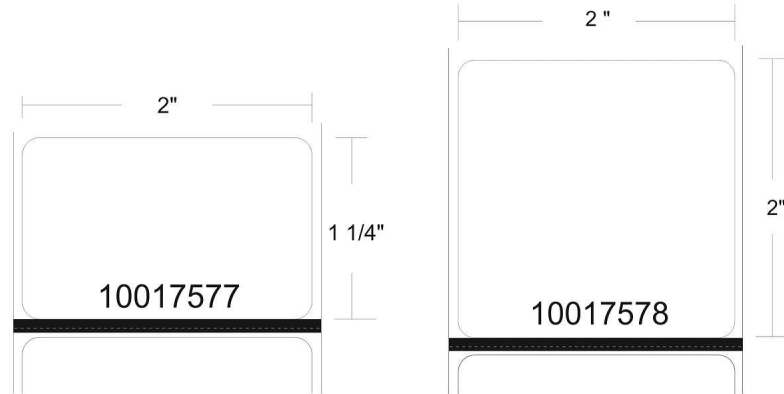

| Size (inches) | PartNumber | ID    | OD   | Quantity Per Roll | Rolls Per Carton | Carton Weight | Stock MTO |
|---------------|------------|-------|------|-------------------|------------------|---------------|-----------|
| 2" x 1.25"    | 10017577   | 0.75" | 2.2" | 380               | 12               | 3 lbs.        | Stock     |
| 2" x 2"       | 10017578   | 0.75" | 2.2" | 245               | 12               | 3 lbs.        | Stock     |

Labels equipped with protective overvarnish.

## PolyPro 4000T

A thermal transfer Kimdura® polypropylene label with a permanent acrylic adhesive. For use in water temperatures over 160°F.

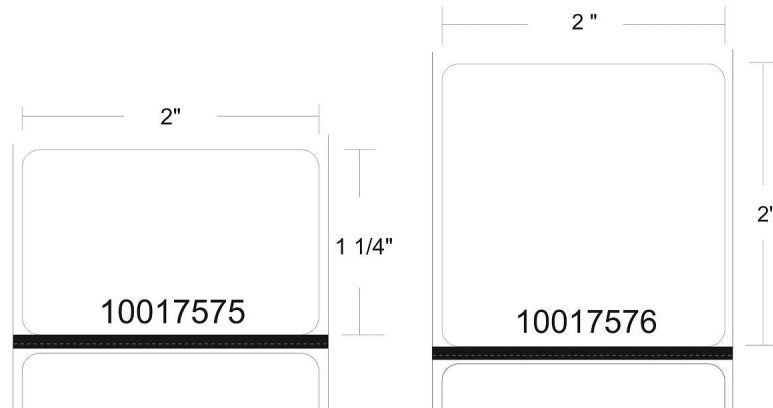

| Size (inches) | PartNumber | ID    | OD   | Quantity Per Roll | Rolls Per Carton | Carton Weight | Stock MTO | Ribbon      |
|---------------|------------|-------|------|-------------------|------------------|---------------|-----------|-------------|
| 2" x 1.25"    | 10017575   | 0.75" | 2.6" | 375               | 12               | 3 lbs.        | Stock     | 05555BK110D |
| 2" x 2"       | 10017576   | 0.75" | 2.6" | 245               | 12               | 3 lbs.        | Stock     | 05555BK110D |

Stock - ships within one business day, Made to order - ships within 6 business days.  
Prices effective January 2015 - All prices subject to change without notice.

Need a custom solution? Call for a quote today: +1 866 230 9495





SEE MORE.  
DO MORE.

# Breast Milk Tracking

## Meditech

### PolyPro 4000T

A thermal transfer Kimdura® polypropylene label with a permanent acrylic adhesive. For use in water temperatures over 160°F.

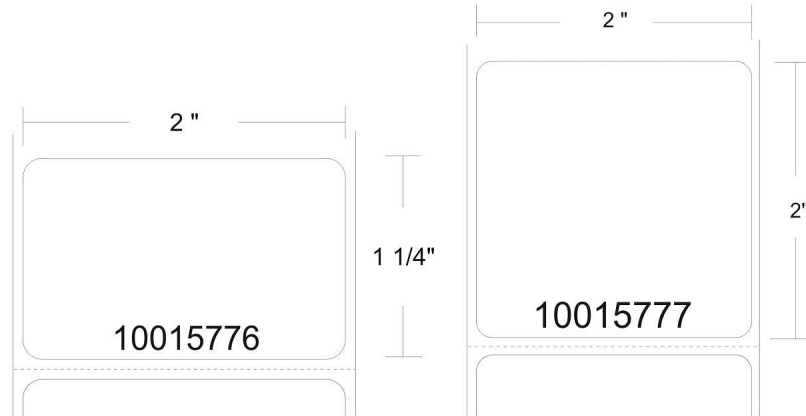

| Size (inches) | PartNumber | ID    | OD   | Quantity Per Roll | Rolls Per Carton | Carton Weight | Stock MTO | Ribbon      |
|---------------|------------|-------|------|-------------------|------------------|---------------|-----------|-------------|
| 2" x 2"       | 10015777   | 0.75" | 2.6" | 245               | 12               | 3 lbs.        | Stock     | 05555BK110D |
| 2" x 1.25"    | 10015776   | 0.75" | 2.6" | 375               | 12               | 3 lbs.        | Stock     | 05555BK110D |

Stock - ships within one business day, Made to order - ships within 6 business days.  
Prices effective January 2015 - All prices subject to change without notice.

Need a custom solution? Call for a quote today: +1 866 230 9495



SEE MORE.  
DO MORE.

# Breast Milk Tracking

## CareFusion

### Z-Ultimate 4000T

A thermal transfer, pearl white, gloss polyester label with a high performance acrylic adhesive. Provides unparalleled smear and scratch resistance and resistance to moderate chemicals.

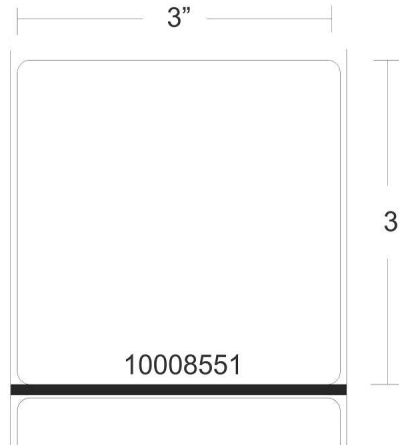

| Size (inches) | PartNumber | ID    | OD   | Quantity Per Roll | Rolls Per Carton | Carton Weight | Stock MTO | Ribbon       |
|---------------|------------|-------|------|-------------------|------------------|---------------|-----------|--------------|
| 3" x 3"       | 10008551   | 0.75" | 2.6" | 230               | 12               | 16 lbs.       | Stock     | 06200BK08345 |

Stock - ships within one business day, Made to order - ships within 6 business days.  
Prices effective January 2015 - All prices subject to change without notice.

Need a custom solution? Call for a quote today: +1 866 230 9495



SEE MORE.  
DO MORE.

# Multipurpose

## General

### Z-Perform 2000D

A white, coated direct thermal paper label with an all-temp permanent acrylic adhesive.

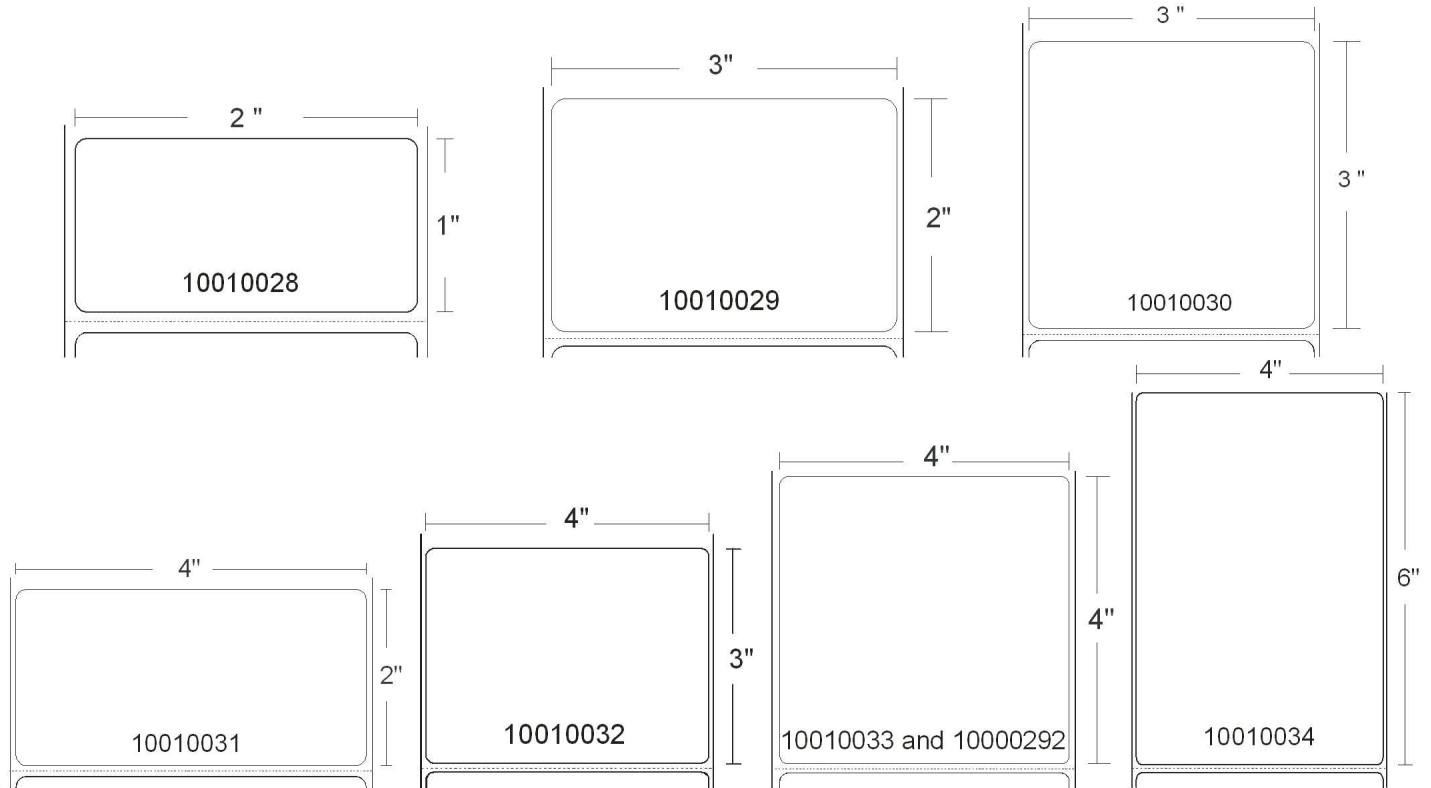

| Size (inches) | PartNumber | ID | OD | Quantity Per Roll | Rolls Per Carton | Carton Weight | Stock MTO |
|---------------|------------|----|----|-------------------|------------------|---------------|-----------|
| 2" x 1"       | 10010028   | 1" | 5" | 2,340             | 6                | 10 lbs        | Stock     |
| 3" x 2"       | 10010029   | 1" | 5" | 1,240             | 6                | 11 lbs.       | Stock     |
| 3" x 3"       | 10010030   | 1" | 5" | 840               | 6                | 11 lbs.       | Stock     |
| 4" x 2"       | 10010031   | 1" | 5" | 1,240             | 6                | 12 lbs.       | Stock     |
| 4" x 3"       | 10010032   | 1" | 5" | 840               | 6                | 12 lbs.       | Stock     |
| 4" x 4"       | 10000292   | 3" | 8" | 1,500             | 4                | 27 lbs.       | Stock     |
| 4" x 4"       | 10010033   | 1" | 5" | 640               | 6                | 12 lbs.       | Stock     |
| 4" x 6"       | 10010034   | 1" | 5" | 430               | 6                | 12 lbs.       | Stock     |

Stock - ships within one business day, Made to order - ships within 6 business days.  
Prices effective January 2015 - All prices subject to change without notice.

Need a custom solution? Call for a quote today: +1 866 230 9495



SEE MORE.  
DO MORE.

# Multipurpose

## General

### Z-Perform 2000D Floodcoated

A coated direct thermal paper label with an all-temp permanent acrylic adhesive.

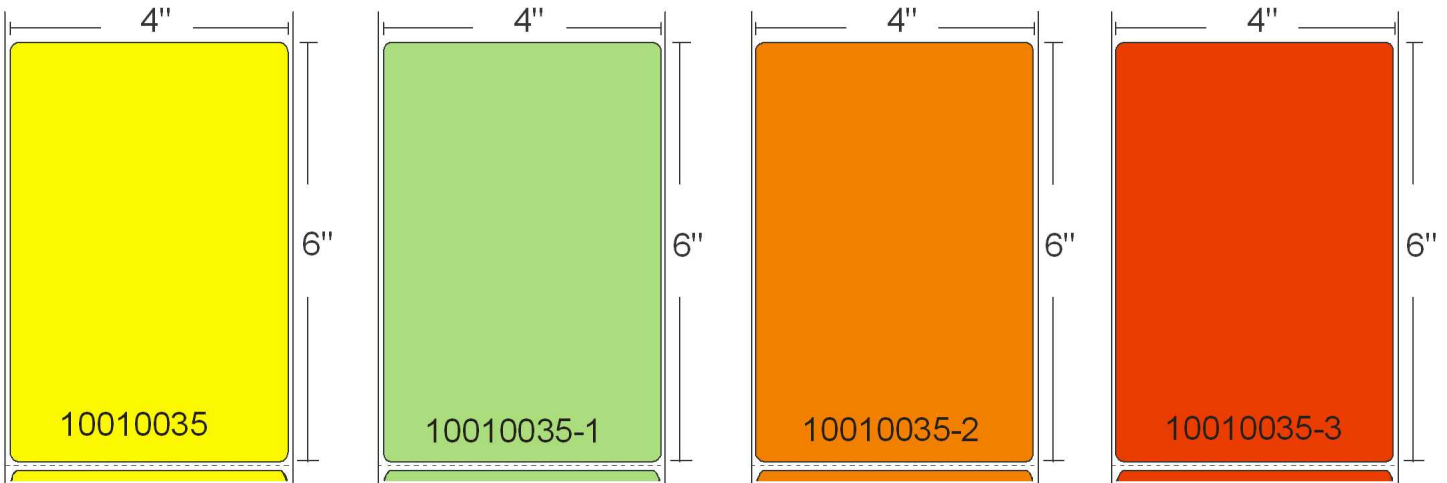

| Size (inches) | PartNumber | ID | OD | Color  | Quantity Per Roll | Rolls Per Carton | Carton Weight | Stock MTO |
|---------------|------------|----|----|--------|-------------------|------------------|---------------|-----------|
| 4" x 6"       | 10010035   | 1" | 5" | Yellow | 430               | 6                | 12 lbs.       | Stock     |
| 4" x 6"       | 10010035-1 | 1" | 5" | Green  | 430               | 6                | 12 lbs.       | Stock     |
| 4" x 6"       | 10010035-2 | 1" | 5" | Orange | 430               | 6                | 12 lbs.       | Stock     |
| 4" x 6"       | 10010035-3 | 1" | 5" | Red    | 430               | 6                | 12 lbs.       | Stock     |

Stock - ships within one business day, Made to order - ships within 6 business days.  
Prices effective January 2015 - All prices subject to change without notice.

Need a custom solution? Call for a quote today: +1 866 230 9495



SEE MORE.  
DO MORE.

# Multipurpose

## General

### Z-Select 4000D

A direct thermal, bright white coated paper label with an all-temp permanent acrylic adhesive

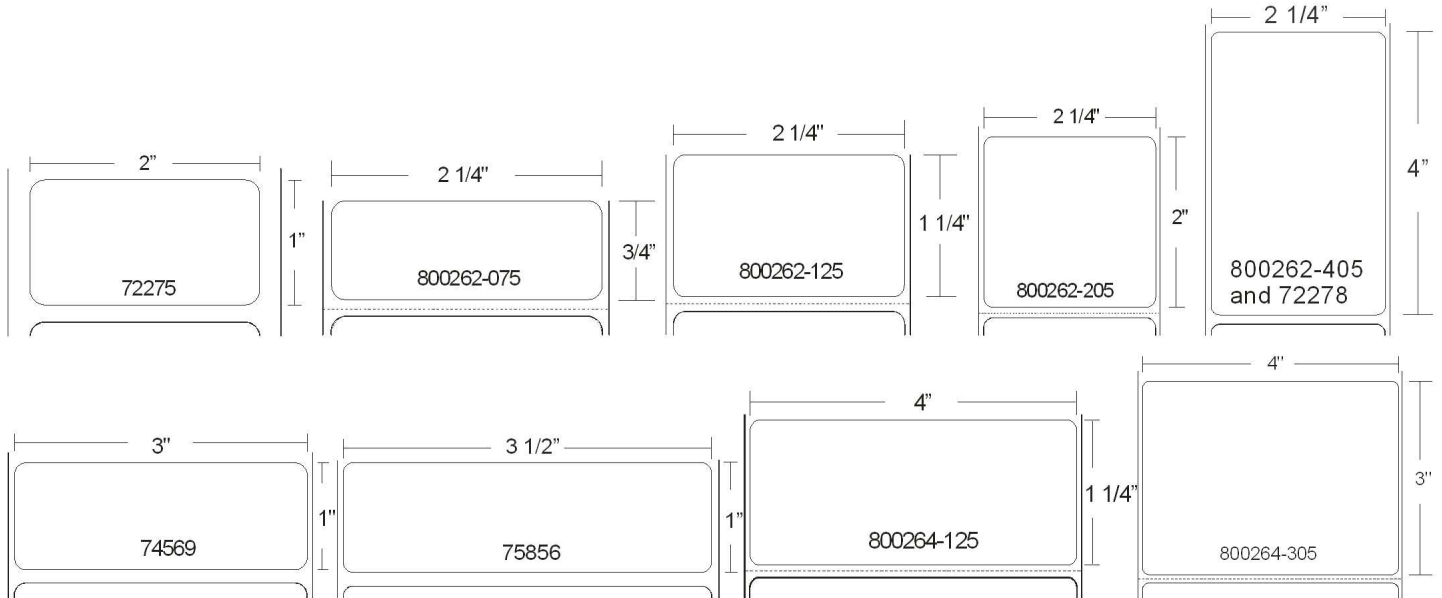

| Size (inches) | PartNumber | ID | OD | Quantity Per Roll | Rolls Per Carton | Carton Weight | Stock MTO |
|---------------|------------|----|----|-------------------|------------------|---------------|-----------|
| 2" x 1"       | 72275      | 3" | 8" | 4,620             | 8                | 22 lbs.       | Stock     |
| 2.25" x 0.75" | 10015340   | 1" | 5" | 3,315             | 12               | 20 lbs.       | Stock     |
| 2.25" x 1.25" | 10015341   | 1" | 5" | 2,100             | 12               | 20 lbs.       | Stock     |
| 2.25" x 2"    | 10015342   | 1" | 5" | 1,370             | 12               | 20 lbs.       | Stock     |
| 2.25" x 4"    | 10015343   | 1" | 5" | 700               | 12               | 20 lbs.       | Stock     |
| 2.25" x 4"    | 72278      | 3" | 8" | 1,260             | 8                | 25 lbs.       | Stock     |
| 3" x 1"       | 74569      | 3" | 8" | 5,120             | 6                | 24 lbs.       | Stock     |
| 3.5" x 1"     | 75856      | 3" | 8" | 5,120             | 6                | 29 lbs.       | Stock     |
| 4" x 1.25"    | 10015349   | 1" | 5" | 2,100             | 12               | 28 lbs.       | Stock     |
| 4" x 3"       | 10015344   | 1" | 5" | 930               | 12               | 30 lbs.       | Stock     |

Stock - ships within one business day, Made to order - ships within 6 business days.  
Prices effective January 2015 - All prices subject to change without notice.

Need a custom solution? Call for a quote today: +1 866 230 9495



SEE MORE.  
DO MORE.

# Specialty

## Radiology

### Z-Select 4000D

A direct thermal, bright white coated paper label with an all-temp permanent acrylic adhesive

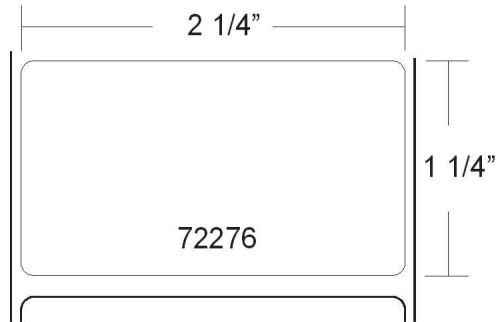

| Size (inches) | PartNumber | ID | OD | Quantity Per Roll | Rolls Per Carton | Carton Weight | Stock MTO |
|---------------|------------|----|----|-------------------|------------------|---------------|-----------|
| 2.25" x 1.25" | 72276      | 3" | 8" | 3,770             | 8                | 24 lbs.       | Stock     |

Stock - ships within one business day, Made to order - ships within 6 business days.  
Prices effective January 2015 - All prices subject to change without notice.

Need a custom solution? Call for a quote today: +1 866 230 9495



SEE MORE.  
DO MORE.

## Specialty

### Sterilization

#### Z-Ultimate 2000T White

A pearl white, gloss polyester thermal transfer label with a high performance permanent acrylic adhesive

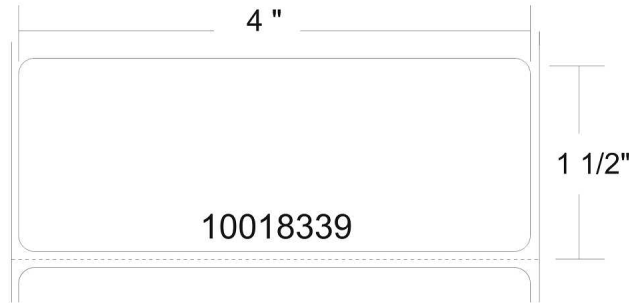

| Size (inches) | PartNumber | ID | OD | Quantity Per Roll | Rolls Per Carton | Carton Weight | Stock MTO | Ribbon       |
|---------------|------------|----|----|-------------------|------------------|---------------|-----------|--------------|
| 4" x 1.5"     | 10018339   | 3" | 8" | 3,800             | 4                | 32 lbs.       | Stock     | 06200BK11045 |

#### Z-Ultimate 3000T White

A pearl white, gloss polyester thermal transfer label with a high performance permanent acrylic adhesive

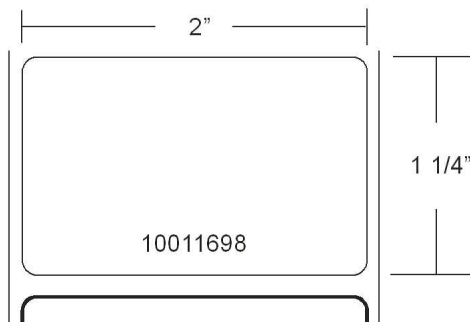

| Size (inches) | PartNumber | ID | OD | Quantity Per Roll | Rolls Per Carton | Carton Weight | Stock MTO | Ribbon       |
|---------------|------------|----|----|-------------------|------------------|---------------|-----------|--------------|
| 2" x 1.25"    | 10011698   | 3" | 8" | 4,270             | 4                | 10 lbs.       | Stock     | 06200BK06045 |





SEE MORE.  
DO MORE.

# Specialty

## Asset Tracking

### PolyPro 4000T

A thermal transfer Kimdura® polypropylene label with a permanent acrylic adhesive.

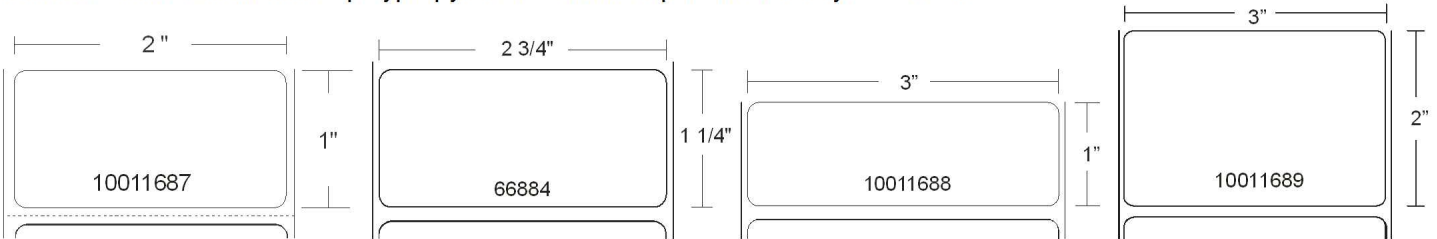

| Size (inches) | PartNumber | ID | OD | Quantity Per Roll | Rolls Per Carton | Carton Weight | Stock MTO | Ribbon       |
|---------------|------------|----|----|-------------------|------------------|---------------|-----------|--------------|
| 2" x 1"       | 10014716   | 3" | 8" | 3,940             | 4                | 10 lbs.       | Stock     | 06100BK06045 |
| 2.75" x 1.25" | 10014717   | 3" | 8" | 3,210             | 4                | 28 lbs.       | Stock     | 06100BK08045 |
| 3" x 1"       | 10011688   | 3" | 8" | 4,350             | 4                | 20 lbs.       | Stock     | 06100BK08045 |
| 3" x 2"       | 10011689   | 3" | 8" | 2,230             | 4                | 20 lbs.       | Stock     | 06100BK08045 |

Stock - ships within one business day, Made to order - ships within 6 business days.  
Prices effective January 2015 - All prices subject to change without notice.

Need a custom solution? Call for a quote today: +1 866 230 9495



SEE MORE.  
DO MORE.

# Wristbanding

## HC100 Wristband Cartridges

### Z-Band UltraSoft Kit

Ultra-soft and flexible direct thermal polypropylene and vinyl wristband with an adhesive tamper-evident tab for securement. Scannable up to 14 days. Wristbands contained in an easy-to-load cartridge for the HC100 printer.

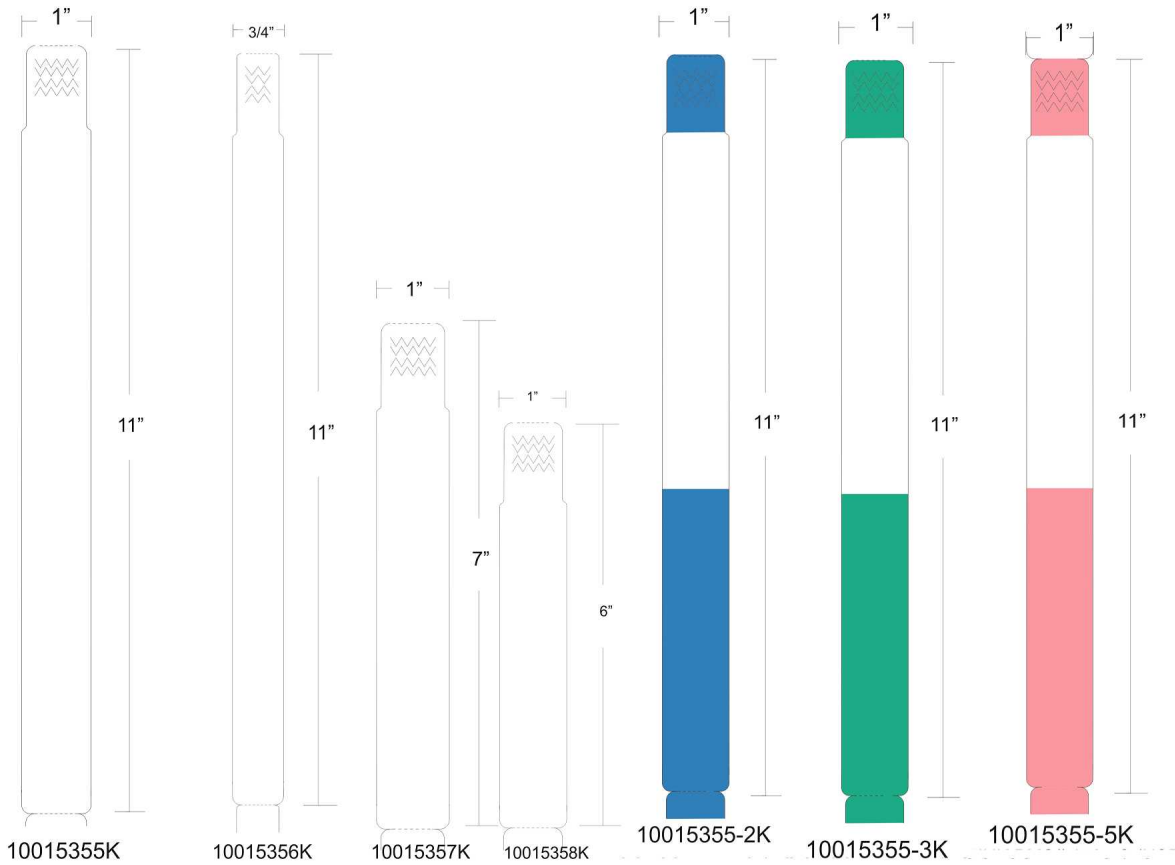

| PartNumber  | Size (inches) | Color | Quantity Per Roll | Rolls Per Carton | Carton Weight | Stock MTO |
|-------------|---------------|-------|-------------------|------------------|---------------|-----------|
| 10015355-2K | 1" x 11"      | Blue  | 175               | 6                | 6 lbs.        | Stock     |
| 10015355-3K | 1" x 11"      | Green | 175               | 6                | 6 lbs.        | Stock     |
| 10015355-5K | 1" x 11"      | Pink  | 175               | 6                | 6 lbs.        | Stock     |
| 10015355K   | 1" x 11"      | White | 175               | 6                | 6 lbs.        | Stock     |
| 10015356K   | 0.75" x 11"   | White | 175               | 6                | 6 lbs.        | Stock     |
| 10015357K   | 1" x 7"       | White | 250               | 6                | 6 lbs.        | Stock     |
| 10015358K   | 1" x 6"       | White | 300               | 6                | 6 lbs.        | Stock     |

Must be ordered in carton quantities. Each part number represents 1 carton.

Stock - ships within one business day, Made to order - ships within 6 business days.  
Prices effective January 2015 - All prices subject to change without notice.

Need a custom solution? Call for a quote today: +1 866 230 9495



SEE MORE.  
DO MORE.

# Wristbanding

## HC100 Wristband Cartridges

### Z-Band Direct Kit

Direct thermal polypropylene wristband with an adhesive tamper-evident tab for securement. Scannable up to 14 days. Wristbands contained in an easy-to-load cartridge for the HC100 printer.

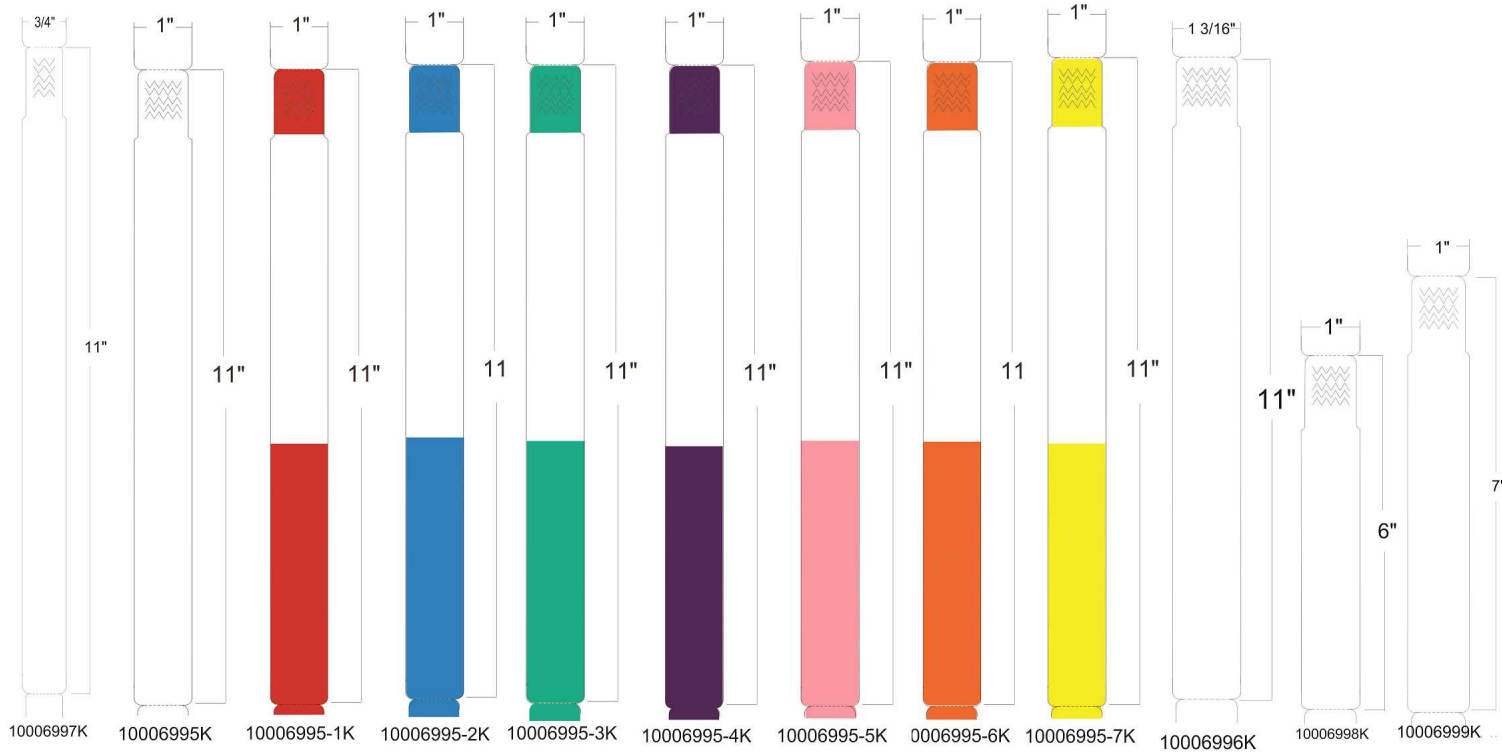

| PartNumber  | Size (inches) | Color  | Quantity Per Roll | Rolls Per Carton | Carton Weight | Stock MTO |
|-------------|---------------|--------|-------------------|------------------|---------------|-----------|
| 10006997K   | 0.75" x 11"   | White  | 200               | 6                | 6 lbs.        | Stock     |
| 10006995K   | 1" x 11"      | White  | 200               | 6                | 6 lbs.        | Stock     |
| 10006995-1K | 1" x 11"      | Red    | 200               | 6                | 6 lbs.        | Stock     |
| 10006995-2K | 1" x 11"      | Blue   | 200               | 6                | 6 lbs.        | Stock     |
| 10006995-3K | 1" x 11"      | Green  | 200               | 6                | 6 lbs.        | Stock     |
| 10006995-4K | 1" x 11"      | Purple | 200               | 6                | 6 lbs.        | Stock     |
| 10006995-5K | 1" x 11"      | Pink   | 200               | 6                | 6 lbs.        | Stock     |
| 10006995-6K | 1" x 11"      | Orange | 200               | 6                | 6 lbs.        | Stock     |
| 10006995-7K | 1" x 11"      | Yellow | 200               | 6                | 6 lbs.        | Stock     |
| 10006996K   | 1.1875" x 11" | White  | 200               | 6                | 6 lbs.        | Stock     |
| 10006998K   | 1" x 6"       | White  | 350               | 6                | 6 lbs.        | Stock     |
| 10006999K   | 1" x 7"       | White  | 300               | 6                | 6 lbs.        | Stock     |

Must be ordered in carton quantities. Each part number represents 1 carton.

Stock - ships within one business day, Made to order - ships within 6 business days.  
Prices effective January 2015 - All prices subject to change without notice.

Need a custom solution? Call for a quote today: +1 866 230 9495



SEE MORE.  
DO MORE.

# Wristbanding

## HC100 Wristband Cartridges

### Z-Band Comfort Kit

Light-weight and flexible direct thermal polypropylene wristband with an adhesive tamper-evident tab for securement. Scannable up to 7 days. Wristbands contained in an easy-to-load cartridge for the HC100 printer.

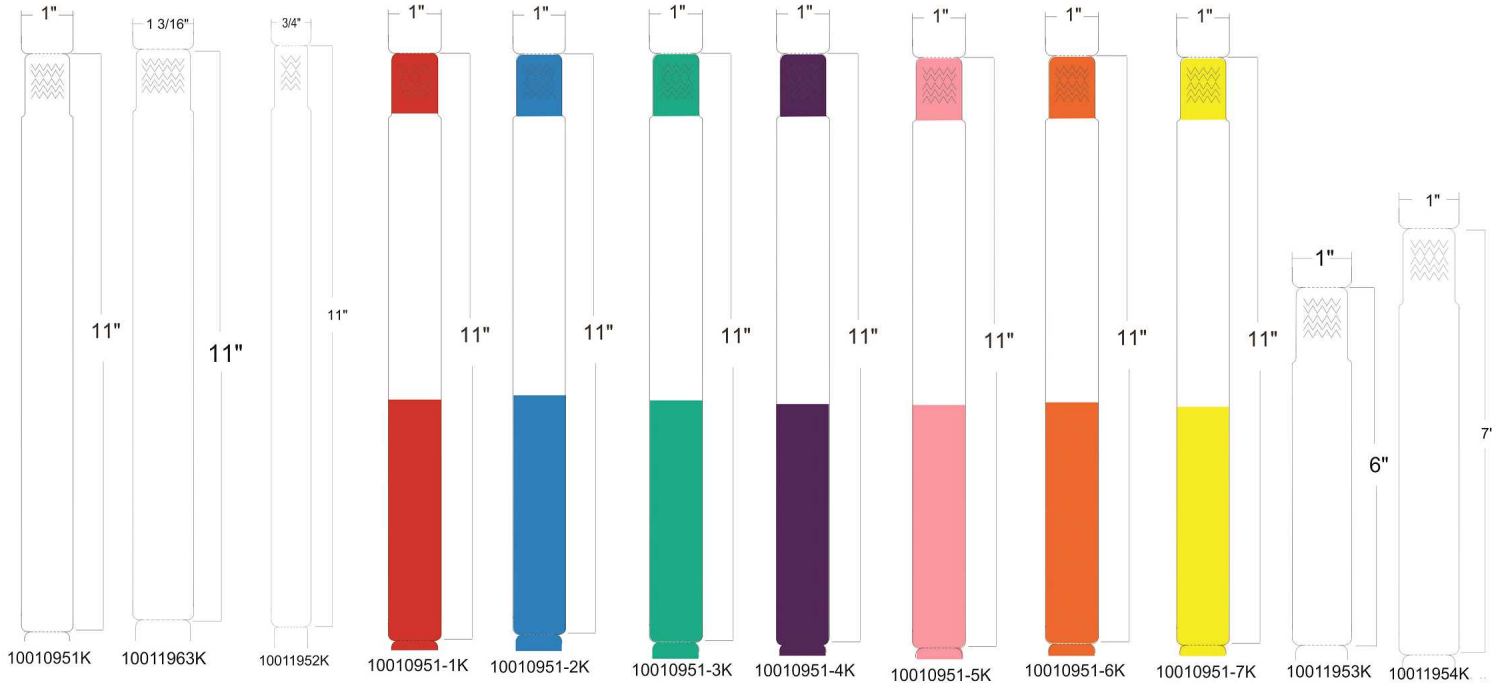

| PartNumber  | Size (inches) | Color  | Quantity Per Roll | Rolls Per Carton | Carton Weight | Stock MTO |
|-------------|---------------|--------|-------------------|------------------|---------------|-----------|
| 10010951K   | 1" x 11"      | White  | 300               | 6                | 6 lbs.        | Stock     |
| 10011963K   | 1.875" x 11"  | White  | 300               | 6                | 6 lbs.        | Stock     |
| 10011952K   | 0.75" x 11"   | White  | 300               | 6                | 6 lbs.        | Stock     |
| 10010951-1K | 1" x 11"      | Red    | 300               | 6                | 6 lbs.        | Stock     |
| 10010951-2K | 1" x 11"      | Blue   | 300               | 6                | 6 lbs.        | Stock     |
| 10010951-3K | 1" x 11"      | Green  | 300               | 6                | 6 lbs.        | Stock     |
| 10010951-4K | 1" x 11"      | Purple | 300               | 6                | 6 lbs.        | Stock     |
| 10010951-5K | 1" x 11"      | Pink   | 300               | 6                | 6 lbs.        | Stock     |
| 10010951-6K | 1" x 11"      | Orange | 300               | 6                | 6 lbs.        | Stock     |
| 10010951-7K | 1" x 11"      | Yellow | 300               | 6                | 6 lbs.        | Stock     |
| 10011953K   | 1" x 6"       | White  | 600               | 6                | 6 lbs.        | Stock     |
| 10011954K   | 1" x 7"       | White  | 500               | 6                | 6 lbs.        | Stock     |

Must be ordered in carton quantities. Each part number represents 1 carton.

Stock - ships within one business day, Made to order - ships within 6 business days.  
Prices effective January 2015 - All prices subject to change without notice.

Need a custom solution? Call for a quote today: +1 866 230 9495



SEE MORE.  
DO MORE.

# Wristbanding

## HC100 Wristband Cartridges

### Soft Infant Z-Band Direct Kit

A direct thermal white polypropylene wristband with soft nylon lining and an adhesive tab for securement. Wristbands contained in an easy-to-load cartridge for the HC100 printer.



Soft infant band with 2.062" L printable area.  
Narrow adhesive tail loops through to attach.

| PartNumber  | Size (inches)   | Color | Quantity Per Roll | Rolls Per Carton | Carton Weight | Stock MTO |
|-------------|-----------------|-------|-------------------|------------------|---------------|-----------|
| 10007746K^^ | 0.75" x 7.6875" | White | 275               | 6                | 6 lbs.        | Stock     |

^^ Must be ordered in carton quantities. Each part number represents 1 carton.

Stock - ships within one business day, Made to order - ships within 6 business days.  
Prices effective January 2015 - All prices subject to change without notice.

Need a custom solution? Call for a quote today: +1 866 230 9495



SEE MORE.  
DO MORE.

# Wristbanding

## HC100 Wristband Cartridges

### Z-Band QuickClip Kit

Direct thermal polypropylene wristband with secure clip closures. Scannable up to 14 days. Wristbands contained in an easy-to-load cartridge for the HC100 printer.

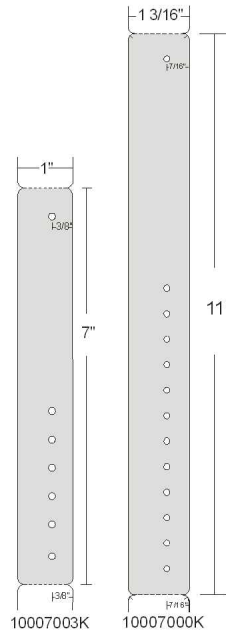

| PartNumber | Size (inches) | Color | Quantity Per Roll | Rolls Per Carton | Carton Weight | Stock MTO |
|------------|---------------|-------|-------------------|------------------|---------------|-----------|
| 10007000K* | 1.1875" x 11" | White | 260               | 4                | 6 lbs.        | Stock     |
| 10007003K^ | 1" x 7"       | White | 390               | 3                | 6 lbs.        | Stock     |

^(1 x 7) QuickClip: Includes 3 wristband cartridges and 1,450 white clips. Color clips sold separately.

\*(1.1875 x 11) QuickClip: Includes 4 wristband cartridges and 1,160 white clips. Color clips sold separately.

Must be ordered in carton quantities. Each part number represents 1 carton.

### Color Clips for Z-Band Quick Clip

| PartNumber   | Color  | Quantity Per Pack | Stock MTO |
|--------------|--------|-------------------|-----------|
| 97032-Pink   | Pink   | 275               | Stock     |
| 97032-Red    | Red    | 275               | Stock     |
| 97032-Blue   | Blue   | 275               | Stock     |
| 97032-Green  | Green  | 275               | Stock     |
| 97032-Yellow | Yellow | 275               | Stock     |
| 97032-Purple | Purple | 275               | Stock     |

Stock - ships within one business day, Made to order - ships within 6 business days.  
Prices effective January 2015 - All prices subject to change without notice.

Need a custom solution? Call for a quote today: +1 866 230 9495



SEE MORE.  
DO MORE.

# Wristbanding

## Z-Band UltraSoft

### Z-Band UltraSoft Wristbands

Ultra-soft and flexible direct thermal polypropylene and vinyl wristband with an adhesive tamper-evident tab for securement. Scannable up to 14 days.

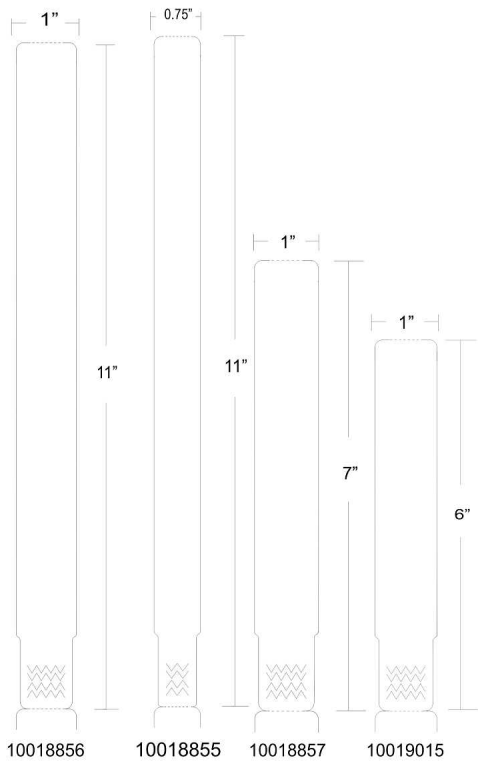

| Size (inches) | PartNumber | ID | OD | Color | Quantity Per Roll | Rolls Per Carton | Carton Weight | Stock MTO |
|---------------|------------|----|----|-------|-------------------|------------------|---------------|-----------|
| 0.75" x 11"   | 10018855   | 1" | 5" | White | 175               | 6                | 6 lbs.        | Stock     |
| 1" x 11"      | 10018856   | 1" | 5" | White | 175               | 6                | 6 lbs.        | Stock     |
| 1" x 7"       | 10018857   | 1" | 5" | White | 250               | 6                | 6 lbs.        | Stock     |
| 1" x 6"       | 10019015   | 1" | 5" | White | 300               | 6                | 6 lbs.        | Stock     |

Stock - ships within one business day, Made to order - ships within 6 business days.  
Prices effective January 2015 - All prices subject to change without notice.

Need a custom solution? Call for a quote today: +1 866 230 9495





SEE MORE.  
DO MORE.

# Wristbanding

## Z-Band Direct

### Z-Band Direct Wristbands

Direct thermal polypropylene wristband with an adhesive tamper-evident tab for securement. Scannable up to 14 days.

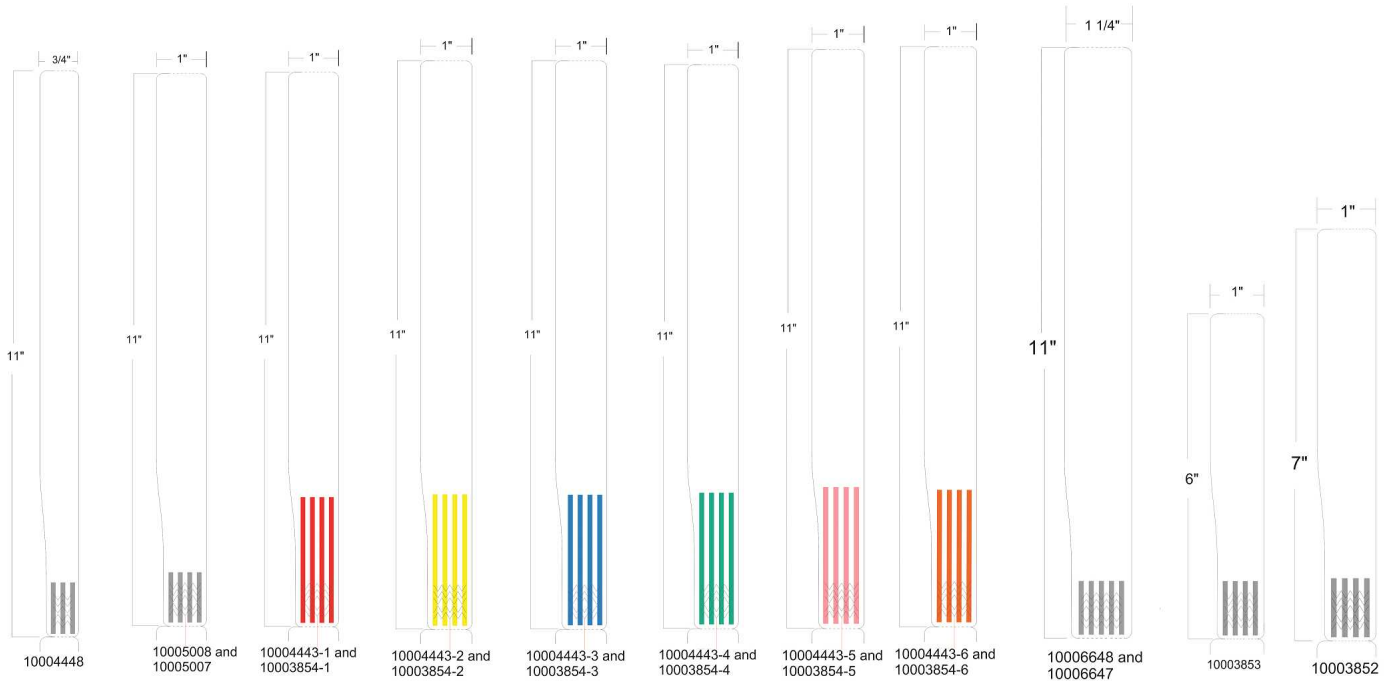

| Size (inches) | PartNumber | ID | OD | Color  | Quantity Per Roll | Rolls Per Carton | Carton Weight | Stock MTO |
|---------------|------------|----|----|--------|-------------------|------------------|---------------|-----------|
| 0.75" x 11"   | 10004448   | 1" | 5" | White  | 200               | 6                | 4.8 lbs.      | Stock     |
| 1" x 11"      | 10005008   | 1" | 5" | White  | 200               | 6                | 4.8 lbs.      | Stock     |
| 1" x 11"      | 10005007   | 3" | 8" | White  | 450               | 6                | 9 lbs.        | Stock     |
| 1" x 11"      | 10004443-1 | 1" | 5" | Red    | 200               | 6                | 4.8 lbs.      | Stock     |
| 1" x 11"      | 10003854-1 | 3" | 8" | Red    | 450               | 6                | 9 lbs.        | MTO       |
| 1" x 11"      | 10004443-2 | 1" | 5" | Yellow | 200               | 6                | 4.8 lbs.      | Stock     |
| 1" x 11"      | 10003854-2 | 3" | 8" | Yellow | 450               | 6                | 9 lbs.        | MTO       |
| 1" x 11"      | 10004443-3 | 1" | 5" | Blue   | 200               | 6                | 4.8 lbs.      | Stock     |
| 1" x 11"      | 10003854-3 | 3" | 8" | Blue   | 450               | 6                | 9 lbs.        | MTO       |
| 1" x 11"      | 10004443-4 | 1" | 5" | Green  | 200               | 6                | 4.8 lbs.      | Stock     |
| 1" x 11"      | 10003854-4 | 3" | 8" | Green  | 450               | 6                | 9 lbs.        | MTO       |
| 1" x 11"      | 10004443-5 | 1" | 5" | Pink   | 200               | 6                | 4.8 lbs.      | Stock     |
| 1" x 11"      | 10003854-5 | 3" | 8" | Pink   | 450               | 6                | 9 lbs.        | MTO       |
| 1" x 11"      | 10004443-6 | 1" | 5" | Orange | 200               | 6                | 4.8 lbs.      | Stock     |
| 1" x 11"      | 10003854-6 | 3" | 8" | Orange | 450               | 6                | 9 lbs.        | MTO       |
| 1.25" x 11"   | 10006647   | 1" | 5" | White  | 200               | 6                | 4.8 lbs.      | Stock     |
| 1.25" x 11"   | 10006648   | 3" | 8" | White  | 450               | 6                | 9 lbs.        | Stock     |
| 1" x 6"       | 10003853   | 1" | 5" | White  | 350               | 6                | 4.8 lbs.      | Stock     |
| 1" x 7"       | 10003852   | 1" | 5" | White  | 300               | 6                | 4.8 lbs.      | Stock     |

Stock - ships within one business day, Made to order - ships within 6 business days.  
Prices effective January 2015 - All prices subject to change without notice.

Need a custom solution? Call for a quote today: +1 866 230 9495



SEE MORE.  
DO MORE.

# Wristbanding

## Z-Band Fusion

### Z-Band Fusion Wristbands: 3" ID, 8" OD

Self-laminating direct thermal polypropylene wristband with an adhesive closure and a wristband extender to fit a wide range of wrist sizes. Scannable up to 60 days.

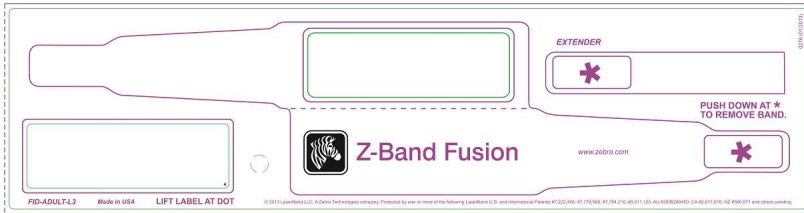

FID-ADULT-L3-3-500T

| Image Area<br>W x L | PartNumber          | Wristband<br>Length | Sheet<br>Width | Color | Bands Per<br>Roll | Rolls/Case | Case<br>Weight | Stock<br>MTO |
|---------------------|---------------------|---------------------|----------------|-------|-------------------|------------|----------------|--------------|
| 2.75" x 0.875"      | FID-ADULT-L3-3-500T | 9.25"               | 3"             | White | 500               | 2          | 7 lbs.         | Stock        |

All Z-Band Fusion part numbers are perforated.

Stock - ships within one business day, Made to order - ships within 6 business days.  
Prices effective January 2015 - All prices subject to change without notice.

Need a custom solution? Call for a quote today: +1 866 230 9495



SEE MORE.  
DO MORE.

# Wristbanding

## Z-Band Fusion

### Z-Band Fusion Wristbands: 1" ID, 5" OD

Self-laminating direct thermal polypropylene wristband with an adhesive closure and a wristband extender to fit a wide range of wrist sizes. Scannable up to 60 days.

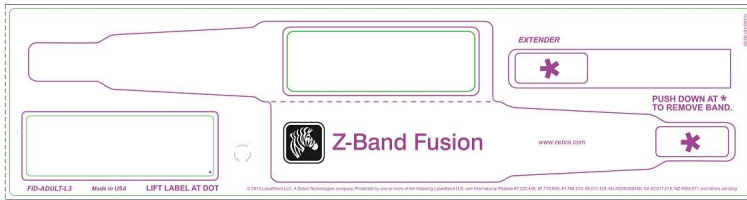

FID-ADULT-L3-1-200T

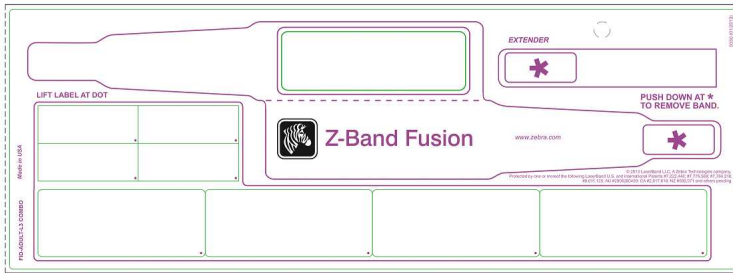

FID-ADULT-L3C-1-200T



FID-PED-L3-1-200T

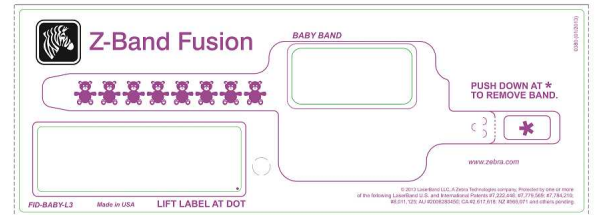

FID-BABY-L3-1-200T

| Image Area<br>W x L | PartNumber           | Wristband<br>Length | Sheet<br>Width | Color | Bands Per<br>Roll | Rolls/Case | Case<br>Weight | Stock<br>MTO |
|---------------------|----------------------|---------------------|----------------|-------|-------------------|------------|----------------|--------------|
| 2.75" x 0.875"      | FID-ADULT-L3-1-200T  | 9.25"               | 3"             | White | 200               | 5          | 7 lbs.         | Stock        |
| 2.75" x 0.875"      | FID-ADULT-L3C-1-200T | 9.25"               | 4"             | White | 200               | 5          | 10 lbs.        | Stock        |
| 2.75" x 0.875"      | FID-PED-L3-1-200T    | 7.375"              | 3"             | White | 200               | 5          | 8 lbs.         | Stock        |
| 1.63" x 0.750"      | FID-BABY-L3-1-200T   | 5.75"               | 3"             | White | 200               | 5          | 8 lbs.         | Stock        |

All Z-Band Fusion part numbers are perforated.

Stock - ships within one business day, Made to order - ships within 6 business days.  
Prices effective January 2015 - All prices subject to change without notice.

Need a custom solution? Call for a quote today: +1 866 230 9495



SEE MORE.  
DO MORE.

# Wristbanding

## Z-Band Fusion

### Z-Band Fusion Infant ID Tags

Self-laminating direct thermal polypropylene infant tags, perfect for use in the NICU where the average infant stay exceeds 14 days. Can be used in conjunction with the ComfyCuff foam wristband, SwaddleBand and Vinyl Infant Wristband Solution. Latex-free.



FID-BABY-T-1-500

FID-BABY-T-3-1M

| Image Area<br>W x L | PartNumber       | ID/OD        | Sheet<br>Width | Color | Tags/Roll | Rolls/Case | Case<br>Weight | Stock<br>MTO |
|---------------------|------------------|--------------|----------------|-------|-----------|------------|----------------|--------------|
| 1.75" x 0.875"      | FID-BABY-T-1-500 | 1" ID, 5" OD | 2.50"          | White | 500       | 2          | 7 lbs.         | Stock        |
| 1.75" x 0.875"      | FID-BABY-T-3-1M  | 3" ID, 8" OD | 2.50"          | White | 1,000     | 1          | 7 lbs.         | Stock        |

All Z-Band Fusion part numbers are perforated.

Stock - ships within one business day, Made to order - ships within 6 business days.  
Prices effective January 2015 - All prices subject to change without notice.

Need a custom solution? Call for a quote today: +1 866 230 9495



SEE MORE.  
DO MORE.

# Wristbanding

## Quick Clip

### Z-Band Quick Clip Kit

Direct thermal polypropylene wristband with secure clip closures. Scannable up to 14 days.

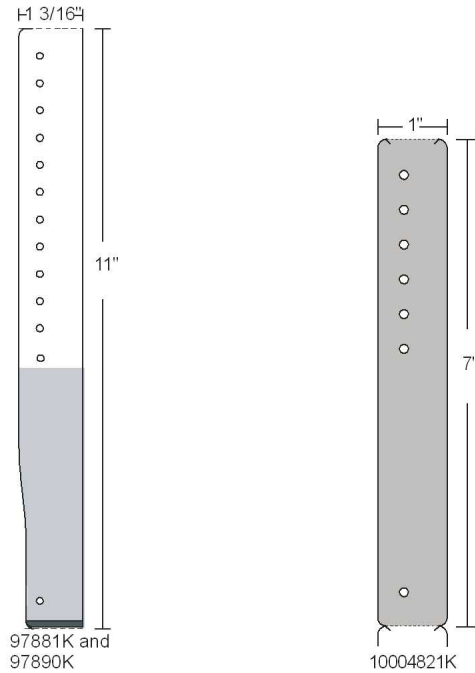

| Size (inches) | PartNumber             | ID | OD | Quantity Per Roll | Rolls Per Carton | Carton Weight | Stock MTO |
|---------------|------------------------|----|----|-------------------|------------------|---------------|-----------|
| 1" x 7"       | 10004821K <sup>^</sup> | 1" | 5" | 390               | 6                | 10 lbs.       | Stock     |
| 1.1875" x 11" | 97881K <sup>*</sup>    | 1" | 5" | 260               | 6                | 11 lbs.       | Stock     |
| 1.1875" x 11" | 97890K <sup>**</sup>   | 3" | 8" | 550               | 6                | 11 lbs.       | Stock     |

<sup>^</sup> (1 x 7) Includes 6 rolls of perforated wristbands and 2,610 white clips. Color clips sold separately.

<sup>\*</sup> (1.1875 x 11) Includes 6 rolls of perforated wristbands and 1,740 white clips. Color clips sold separately.

<sup>\*\*</sup> (1.1875 x 11) Includes 6 rolls of perforated wristbands and 3,480 white clips. Color clips sold separately.

### Color Clips for Z-Band Quick Clip Wristbands

| PartNumber   | Color  | Quantity Per Pack | Stock MTO |
|--------------|--------|-------------------|-----------|
| 97032-Pink   | Pink   | 275               | Stock     |
| 97032-Red    | Red    | 275               | Stock     |
| 97032-Blue   | Blue   | 275               | Stock     |
| 97032-Green  | Green  | 275               | Stock     |
| 97032-Yellow | Yellow | 275               | Stock     |
| 97032-Purple | Purple | 275               | Stock     |

Stock - ships within one business day, Made to order - ships within 6 business days.  
Prices effective January 2015 - All prices subject to change without notice.

Need a custom solution? Call for a quote today: +1 866 230 9495



SEE MORE.  
DO MORE.

# Wristbanding

## Infant

### Soft Infant Wristband

A direct thermal white polypropylene wristband with soft nylon lining with a t-shaped adjustable design, flat surface print area and an adhesive tab for securement .

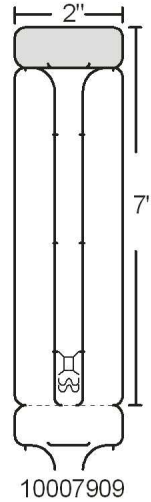

| Size (inches) | PartNumber | Quantity Per Roll | Rolls Per Carton | Carton Weight | Stock MTO |
|---------------|------------|-------------------|------------------|---------------|-----------|
| 2" x 7"       | 10007909   | 275               | 6                | 6 lbs.        | Stock     |

Stock - ships within one business day, Made to order - ships within 6 business days.  
Prices effective January 2015 - All prices subject to change without notice.

Need a custom solution? Call for a quote today: +1 866 230 9495





SEE MORE.  
DO MORE.

# Wristbanding - Non-Printable

## Alert Solutions

### Spot Alert Labels

Spot-alert color-coded labels can be adhered to any Zebra wristband and feature a strong tamper-evident adhesive that causes the label to tear if tampered with. Available in standard color and designation combinations to support the most critical patient conditions.

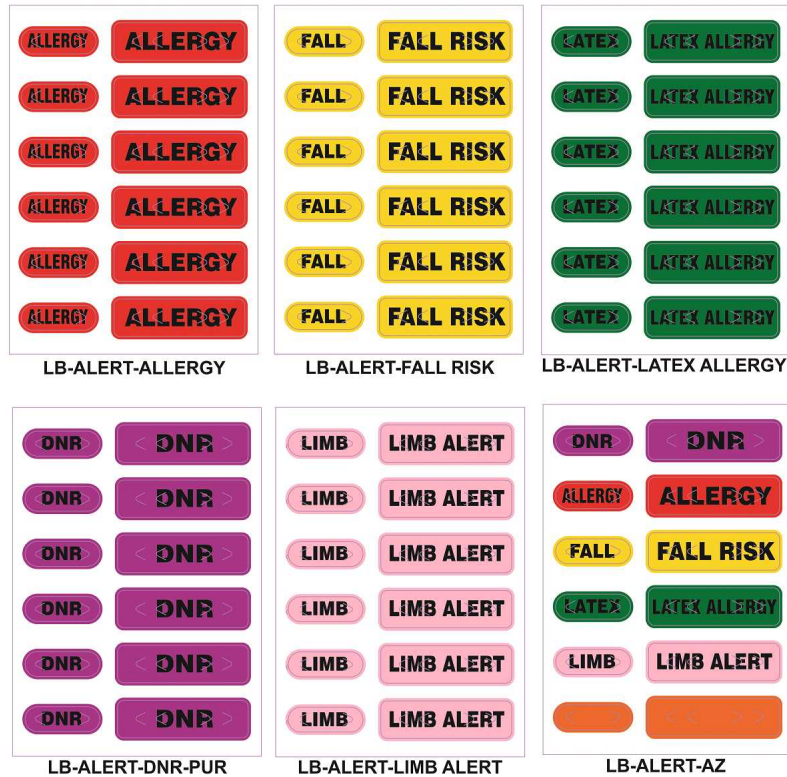

| Sheet Size<br>W x L<br>(inches) | PartNumber            | Alert Designation | Color  | Labels/Form | Forms/Case | Case Weight | Stock<br>MTO |
|---------------------------------|-----------------------|-------------------|--------|-------------|------------|-------------|--------------|
| 2.5" x 3.5"                     | LB-ALERT-ALLERGY      | Allergy           | Red    | 12          | 1,000      | 3 lbs.      | Stock        |
| 2.5" x 3.5"                     | LB-ALERT-FALLRISK     | Fall Risk         | Yellow | 12          | 1,000      | 3 lbs.      | Stock        |
| 2.5" x 3.5"                     | LB-ALERT-DNR-PUR      | DNR               | Purple | 12          | 1,000      | 3 lbs.      | Stock        |
| 2.5" x 3.5"                     | LB-ALERT-LATEXALLERGY | Latex Allergy     | Green  | 12          | 1,000      | 3 lbs.      | Stock        |
| 2.5" x 3.5"                     | LB-ALERT-LIMBALERT    | Limb Alert        | Pink   | 12          | 1,000      | 3 lbs.      | Stock        |
| 2.5" x 3.5"                     | LB-ALERT-AZ           | All               | All    | 12          | 1,000      | 3 lbs.      | Stock        |

Each sheet contains (6) labels sized 1.3125" x 0.375" and (6) labels sized 0.75" x 0.25".

Stock - ships within one business day, Made to order - ships within 6 business days.  
Prices effective January 2015 - All prices subject to change without notice.

Need a custom solution? Call for a quote today: +1 866 230 9495





SEE MORE.  
DO MORE.

# Wristbanding - Non-Printable

## Alert Solutions

### Slim Alert Wristbands

Pre-printed vinyl alert wristbands with an integrated clip closure. Available in standard color and designation combinations to support the most critical patient conditions.

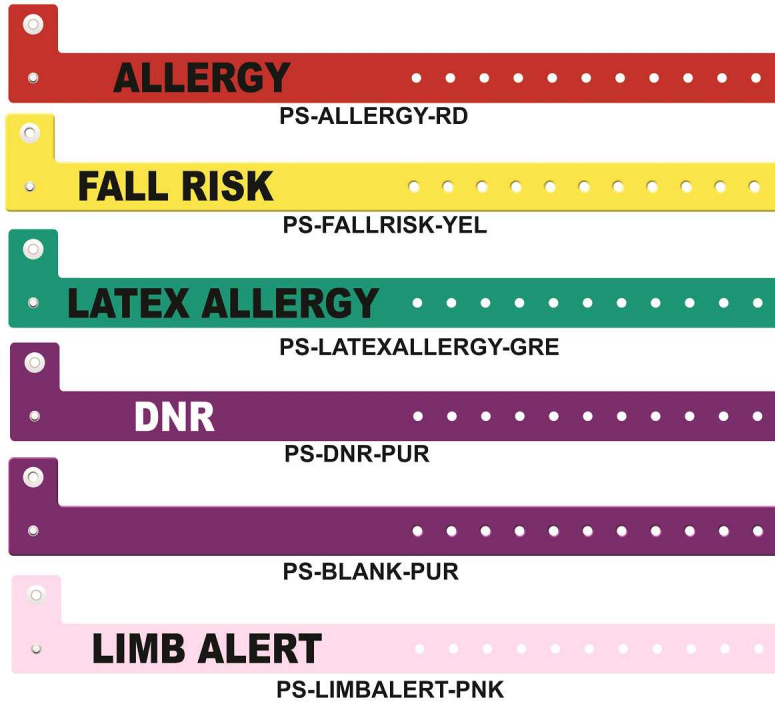

| Size<br>W x L<br>(inches) | PartNumber          | Alert Designation | Color  | Bands/Case | Case Weight | Stock MTO |
|---------------------------|---------------------|-------------------|--------|------------|-------------|-----------|
| 0.625" x 10"              | PS-ALLERGY-RED      | Allergy           | Red    | 500        | 3 lbs.      | Stock     |
| 0.625" x 10"              | PS-FALLRISK-YEL     | Fall Risk         | Yellow | 500        | 3 lbs.      | Stock     |
| 0.625" x 10"              | PS-DNR-PUR          | DNR               | Purple | 500        | 3 lbs.      | Stock     |
| 0.625" x 10"              | PS-LATEXALLERGY-GRE | Latex Allergy     | Green  | 500        | 3 lbs.      | Stock     |
| 0.625" x 10"              | PS-LIMBALERT-PNK    | Limb Alert        | Pink   | 500        | 3 lbs.      | Stock     |
| 0.625" x 10"              | PS-BLANK-PUR        | Blank             | Purple | 500        | 3 lbs.      | Stock     |

Stock - ships within one business day, Made to order - ships within 6 business days.  
Prices effective January 2015 - All prices subject to change without notice.

Need a custom solution? Call for a quote today: +1 866 230 9495



SEE MORE.  
DO MORE.

## Wristbanding - Non-Printable

### Alert Solutions

#### Tyvek Alert Wristbands

Color-coded Tyvek® alert wristbands with a tamper-evident adhesive closure. Available in standard color and designation combinations to support the most critical patient conditions.



| Size<br>W x L<br>(inches) | PartNumber      | Alert Designation             | Color  | Bands/Case | Case<br>Weight | Stock MTO |
|---------------------------|-----------------|-------------------------------|--------|------------|----------------|-----------|
| 0.625" x 10"              | TY-ALLERGY      | Allergy                       | Red    | 1,000      | 2 lbs.         | Stock     |
| 0.625" x 10"              | TY-FALLRISK     | Fall Risk                     | Yellow | 1,000      | 2 lbs.         | Stock     |
| 0.625" x 10"              | TY-DNR-PUR      | DNR                           | Purple | 1,000      | 2 lbs.         | Stock     |
| 0.625" x 10"              | TY-LATEXALLERGY | Latex Allergy                 | Green  | 1,000      | 2 lbs.         | Stock     |
| 0.625" x 10"              | TY-LIMBALERT    | Limb Alert                    | Pink   | 1,000      | 2 lbs.         | Stock     |
| 0.625" x 10"              | TY-ISOLATION    | Isolation                     | Green  | 1,000      | 2 lbs.         | Stock     |
| 0.625" x 10"              | TY-NOSTICKNOBP  | No Needles, No Blood Pressure | Pink   | 1,000      | 2 lbs.         | Stock     |
| 0.625" x 10"              | TY-OSARISK      | Obstructive Sleep Apnea       | Blue   | 1,000      | 2 lbs.         | Stock     |
| 0.625" x 10"              | TY-BLANK-SIL    | Blank                         | Silver | 1,000      | 2 lbs.         | Stock     |



SEE MORE.  
DO MORE.

# Wristbanding - Non-Printable

## OmniBand

### OmniBand

Self-laminating wristband with a tamper evident adhesive closure that can be used in conjunction with virtually any printed label. Includes wristband extender to fit a wide variety of wrist sizes.

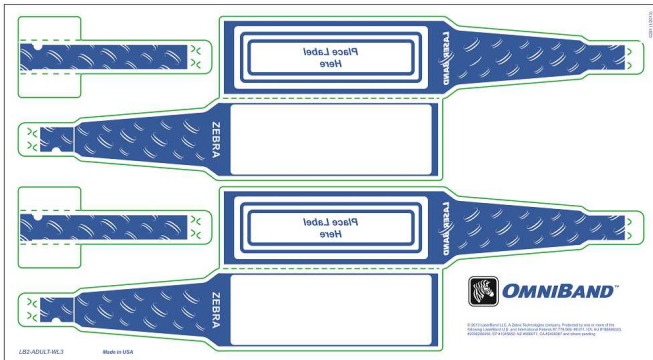

**LB2-ADULT-WL3**  
Available in white, red, blue and orange

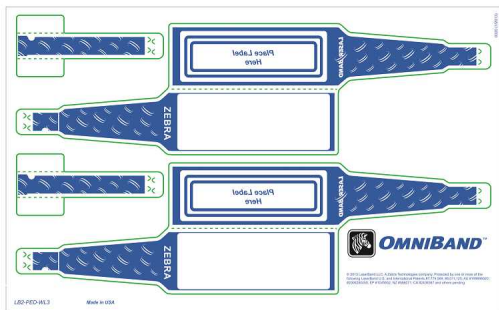

**LB2-PED-WL3**  
Available in white

| Max Label Size<br>W x L<br>(inches) | PartNumber        | Wristband Length | Extender Length | Color  | Bands/Case | Case Weight | Stock MTO |
|-------------------------------------|-------------------|------------------|-----------------|--------|------------|-------------|-----------|
| 3.25" x 1.00"                       | LB2-ADULT-WL3     | 10"              | 3.25"           | White  | 1,000      | 10 lbs.     | Stock     |
| 3.25" x 1.00"                       | LB2-ADULT-WL3-RED | 10"              | 3.25"           | Red    | 1,000      | 10 lbs.     | MTO       |
| 3.25" x 1.00"                       | LB2-ADULT-WL3-BLU | 10"              | 3.25"           | Blue   | 1,000      | 10 lbs.     | Stock     |
| 3.25" x 1.00"                       | LB2-ADULT-WL3-ORA | 10"              | 3.25"           | Orange | 1,000      | 10 lbs.     | Stock     |
| 2.25" x 0.75"                       | LB2-PED-WL3       | 8"               | 2.625"          | White  | 1,000      | 7 lbs.      | Stock     |

Sheet measures 4.25" x 11".  
500 sheets/case containing (2) wristbands and (2) extenders each.

Stock - ships within one business day, Made to order - ships within 6 business days.  
Prices effective January 2015 - All prices subject to change without notice.

Need a custom solution? Call for a quote today: +1 866 230 9495



SEE MORE.  
DO MORE.

## Wristbanding - Non-Printable

### Vinyl Infant Wristband Solutions

#### Vinyl Infant Wristband Solutions

Soft, flexible vinyl wristbands for use with Z-Band Fusion Infant ID Tags. The narrow width allows some models of "Abduction Prevention Systems" to be attached. Available in clip or self-locking closure. Self-locking closure can be adjusted with a gentle tug as the infant loses mass around the wrists and ankles within the first 24 hours of birth. Latex-free.

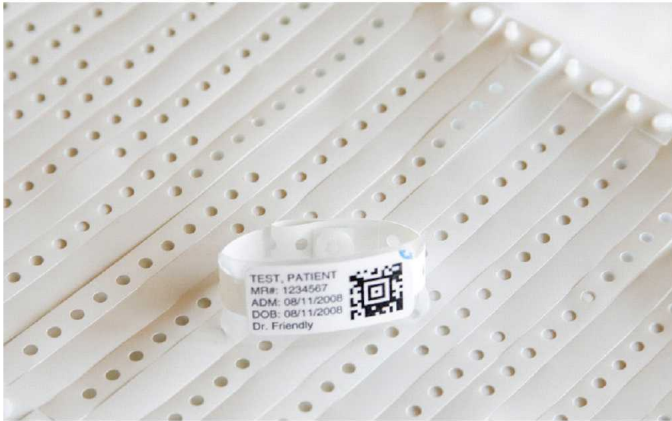

PS-BABY



PS-INFANT-ADJ

\* PS-BABY and PS-INFANT-ADJ are pictured with Z-Band Fusion Infant ID Tags.

| Size<br>W x L<br>(inches) | PartNumber    | Closure Style | Color | Bands/Case | Case Weight | Stock MTO |
|---------------------------|---------------|---------------|-------|------------|-------------|-----------|
| 0.39" x 6.25"             | PS-BABY       | Clip          | White | 250        | 1 lb.       | Stock     |
| 0.39" x 8.5"              | PS-INFANT-ADJ | Self-locking  | White | 250        | 1 lb.       | Stock     |

Stock - ships within one business day, Made to order - ships within 6 business days.  
Prices effective January 2015 - All prices subject to change without notice.

Need a custom solution? Call for a quote today: +1 866 230 9495



SEE MORE.  
DO MORE.

## Wristbanding - Non-Printable

### ComfyCuff Solution

#### ComfyCuff

Soft foam cuff featuring an adjustable Velcro® closure ensuring infant comfort. Can be used in conjunction with Z-Band Fusion Infant ID Tags, ComfyCuff Infant SwaddleBand and ComfyCuff Security Seal.



LB2-BABY-P

\*Pictured with Z-Band Fusion Infant ID Tag

| Size<br>W x L<br>(inches) | PartNumber | Color | Bands/Case | Case Weight | Stock MTO |
|---------------------------|------------|-------|------------|-------------|-----------|
| 1.375" x 5.5"             | LB2-BABY-P | White | 100        | 1 lb.       | Stock     |

#### ComfyCuff Security Seal

Label designed to securely stick to the ComfyCuff material and self-destruct to indicate wristband tampering. Latex-free.



LB2-BABY-CCS

\*Pictured with LB2-BABY-P (ComfyCuff) and Z-Band Fusion Infant ID Tag

| Size<br>W x L<br>(inches) | PartNumber   | Color | Bands/Case | Case Weight | Stock MTO |
|---------------------------|--------------|-------|------------|-------------|-----------|
| 2.875" x 0.4375"          | LB2-BABY-CCS | White | 1,000      | 1 lb.       | Stock     |





SEE MORE.  
DO MORE.

# Wristbanding - Non-Printable

## ComfyCuff Solution

### ComfyCuff Infant Swaddle Band

Soft Tyvek® band that makes identifying a swaddled infant quick and easy. Creates an extension between the ComfyCuff and Z-Band Fusion Infant ID Tags or wristband, allowing the tag to be easily accessible. Latex-free.



LB2-BABY-SWB9

\*Pictured with ComfyCuff and Z-Band Fusion Infant ID Tags

| Size<br>W x L<br>(inches) | PartNumber    | Color | Bands/Case | Case Weight | Stock MTO |
|---------------------------|---------------|-------|------------|-------------|-----------|
| 0.41" x 9"                | LB2-BABY-SWB9 | White | 500        | 1 lb.       | Stock     |

Stock - ships within one business day, Made to order - ships within 6 business days.  
Prices effective January 2015 - All prices subject to change without notice.

Need a custom solution? Call for a quote today: +1 866 230 9495



SEE MORE.  
DO MORE.

# Ribbons

| Ribbon Part # | Width<br>(inches) | Width<br>(mm) | Length<br>(feet) | Length<br>(m) | Quantity<br>Per Carton | Weight | Stock<br>MTO | Printer<br>Type |
|---------------|-------------------|---------------|------------------|---------------|------------------------|--------|--------------|-----------------|
|---------------|-------------------|---------------|------------------|---------------|------------------------|--------|--------------|-----------------|

## 6100 WAX/RESIN

|              |       |       |        |      |    |        |       |          |
|--------------|-------|-------|--------|------|----|--------|-------|----------|
| 6100GS06407  | 2.52" | 64mm  | 244'   | 74m  | 48 | 3 lbs. | Stock | Desktop  |
| 06100BK06045 | 2.36" | 60mm  | 1,476' | 450m | 6  | 5 lbs. | Stock | Tabletop |
| 06100BK08045 | 3.15" | 80mm  | 1,476' | 450m | 6  | 6 lbs. | Stock | Tabletop |
| 06100BK11045 | 4.33" | 110mm | 1,476' | 450m | 6  | 7 lbs. | Stock | Tabletop |

## 5555 WAX/RESIN

|             |       |       |     |     |    |        |       |        |
|-------------|-------|-------|-----|-----|----|--------|-------|--------|
| 05555BK110D | 4.33" | 110mm | 98' | 98' | 10 | 2 lbs. | Stock | Mobile |
|-------------|-------|-------|-----|-----|----|--------|-------|--------|

## 6200 RESIN

|              |       |      |        |      |   |        |       |          |
|--------------|-------|------|--------|------|---|--------|-------|----------|
| 06200BK06045 | 2.36" | 60mm | 1,476' | 450m | 6 | 5 lbs. | Stock | Tabletop |
| 06200BK08345 | 3.27" | 83mm | 1,476' | 450m | 6 | 6 lbs. | Stock | Tabletop |

## IMAGE LOCK

|       |       |       |      |     |    |         |     |         |
|-------|-------|-------|------|-----|----|---------|-----|---------|
| 74941 | 2.50" | 110mm | 244' | 74m | 12 | 8 lbs.  | MTO | Desktop |
| 74943 | 4.30" | 110mm | 244' | 74m | 12 | 12 lbs. | MTO | Desktop |

**MINIMUM ORDER QUANTITY FOR ALL RIBBONS IS 1 CARTON.**

*Stock - ships within one business day, Made to order - ships within 6 business days.  
Prices effective January 2015 - All prices subject to change without notice.*

Need a custom solution? Call for a quote today: **+1 866 230 9495**



[www.L-TronDirect.com](http://www.L-TronDirect.com)

800-830-9523

[info@L-Tron.com](mailto:info@L-Tron.com)

596 Fishers Station Dr | Victor, NY | 14564 | Suite 1 A

[www.L-Tron.com](http://www.L-Tron.com)

Get in touch with us  
on social media!

