

# HEALTHCARE

## SUPPLIES CATALOG



Effective December 5, 2011  
877 ASK ZEBRA  
[www.zebra.com](http://www.zebra.com)





SEE MORE.  
DO MORE.

# Table of Contents

## Healthcare Catalog

<b><i>LAB</i></b>	<b>1-3</b>
MISYS/SUNQUEST.....	1
MICROSCOPE SLIDE.....	2
GENERAL.....	3
<b><i>ISBT 128</i></b>	<b>4</b>
<b><i>MOBILE SPECIMEN COLLECTION</i></b>	<b>5</b>
<b><i>PHARMACY</i></b>	<b>6</b>
<b><i>MULTIPURPOSE</i></b>	<b>7-9</b>
<b><i>SPECIALTY</i></b>	<b>10-11</b>
RADIOLOGY.....	10
STERILIZATION.....	10
ASSET TRACKING.....	11
<b><i>WRISTBANDING</i></b>	<b>12-18</b>
HC100 WRISTBAND CARTRIDGES.....	12-15
WRISTBANDS FOR DESKTOP & TABLETOP PRINTERS.....	16-18
<b><i>RIBBONS</i></b>	<b>19</b>



SEE MORE.  
DO MORE.

# Lab

## MISYS/Sunquest

### 8000D Lab

A paper label with a high-tack permanent acrylic adhesive specifically designed to adhere to small, curved surfaces

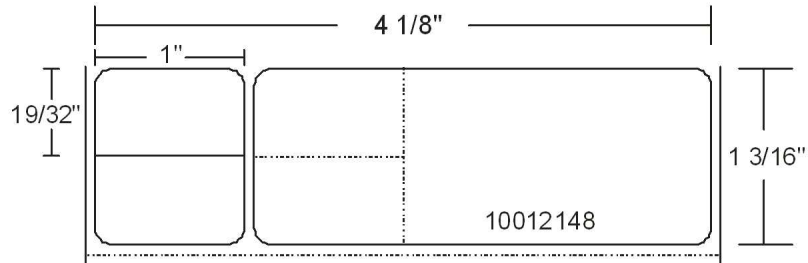

Size (inches)	ID	OD	PartNumber	Carton Weight	Color	Quantity Per Roll	Rolls Per Carton
4.125" x 1.1875"	1"	5"	10012148	20 lbs.	White	2,000	4



SEE MORE.  
DO MORE.

# Lab

## Microscope Slide

### PolyPro 4000T

A Kimdura® polypropylene label with a permanent acrylic adhesive

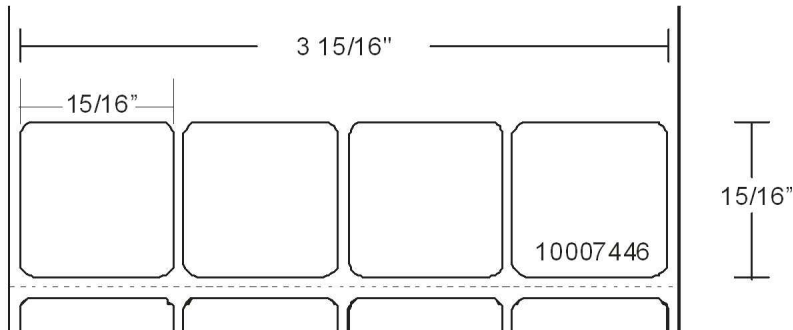

Size (inches)	ID	OD	PartNumber	Quantity Per Roll	Rolls Per Carton	Carton Weight	Ribbon
0.9375" x 0.9375"	1"	5"	10007446	7,400	6	10 lbs.	03200GS11007

### Z-Xtreme 5000T

A thermal transfer, coated label with a high performance permanent acrylic adhesive that will stay put on difficult-to-label surfaces.

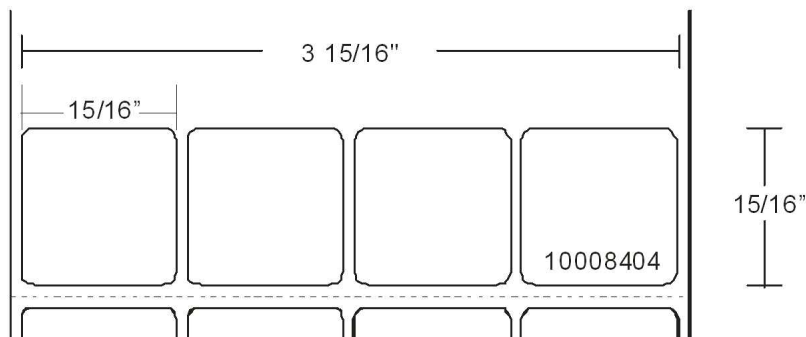

Size (inches)	ID	OD	PartNumber	Quantity Per Roll	Rolls Per Carton	Carton Weight	Ribbon
0.9375" x 0.9375"	1"	5"	10008404	8,760	4	6 lbs.	74943

\* Kit includes 2 rolls of labels and 1 roll of image lock ribbon.



SEE MORE.  
DO MORE.

# Lab

## General

### PolyPro 4000T

A Kimdura® polypropylene label with a permanent acrylic adhesive

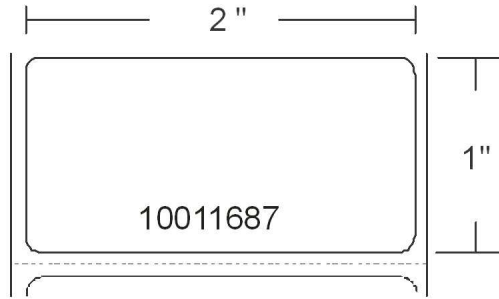

Size (inches)	ID	OD	PartNumber	Quantity Per Roll	Rolls Per Carton	Carton Weight	Ribbon
2" x 1"	3"	8"	10014716	3,940	4	10 lbs.	03200BK06045

### PolyPro 4000D

A polypropylene label with an all-temp permanent acrylic adhesive

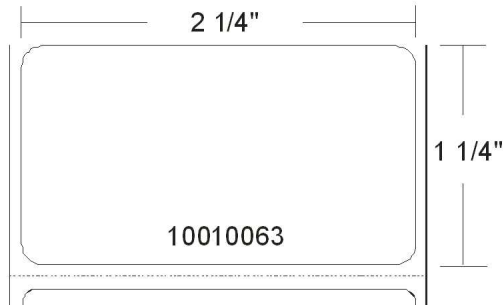

Size (inches)	ID	OD	PartNumber	Quantity Per Roll	Rolls Per Carton	Carton Weight
2.25" x 1.25"	1"	5"	10010063	2,000	6	12 lbs.

### 8000D Lab

A paper label with a high-tack permanent acrylic adhesive specifically designed to adhere to small, curved surfaces

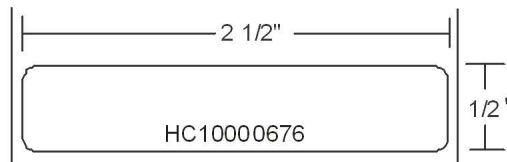

Size (inches)	ID	OD	PartNumber	Color	Quantity Per Roll	Rolls Per Carton	Carton Weight
2.5" x 0.5"	3"	8"	HC10000676	White	9,220	6	30 lbs.



SEE MORE.  
DO MORE.

# ISBT 128

## General

### 8000T Primary Blood Bag Label

Polypropylene label with a permanent acrylic adhesive for direct application to a blood bag

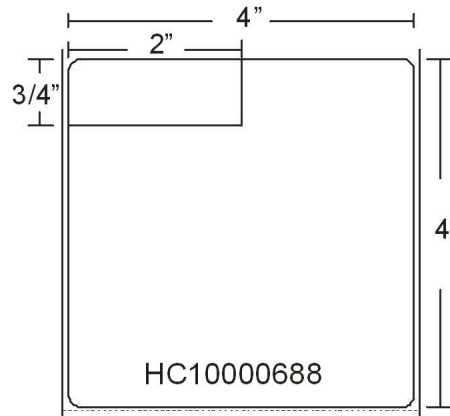

Size (inches)	ID	OD	PartNumber	Quantity Per Roll	Rolls Per Carton	Carton Weight	Ribbon
4" x 4"	3"	8"	HC10000688	1,110	4	24 lbs.	03200BK11045



SEE MORE.  
DO MORE.

# Mobile Specimen Collection

## General

### PolyPro 4000D

A polypropylene label with an all-temp permanent acrylic adhesive

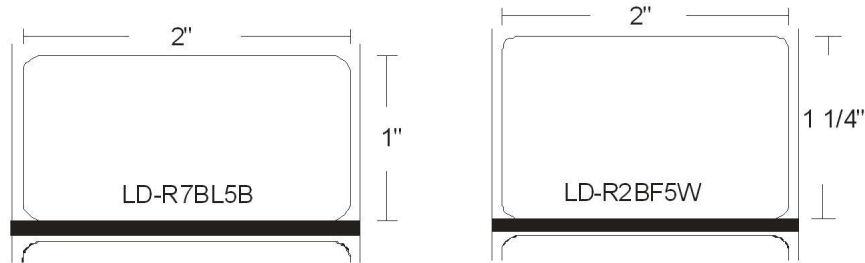

Size (inches)	ID	OD	PartNumber	Quantity Per Roll	Rolls Per Carton	Carton Weight
2" x 1"	0.75"	2"	LD-R7BL5B	350	36	7 lbs.
2" x 1.25"	1"	2"	LD-R2BF5W	280	36	8 lbs.

### Z-Perform 1000D

An uncoated, direct thermal, paper facestock with a permanent acrylic adhesive

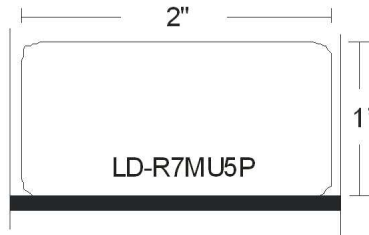

Size (inches)	ID	OD	PartNumber	Quantity Per Roll	Rolls Per Carton	Carton Weight
2" x 1"	0.75"	2"	LD-R7MU5P	350	36	7 lbs.



SEE MORE.  
DO MORE.

# Pharmacy

## General

### Z-Select 4000D

A direct thermal, bright white coated paper label with an all-temp permanent acrylic adhesive

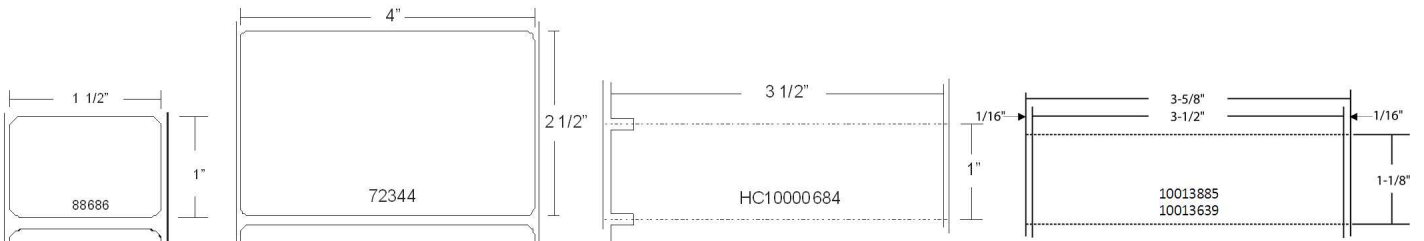

Size (inches)	ID	OD	PartNumber	Quantity Per Roll	Rolls Per Carton	Carton Weight
1.5" x 1"	3"	8"	88686	5,120	14	29 lbs.
3.5" x 1"	3"	8"	HC10000684*	5,760	6	30 lbs.
3.5" x 1.125"	1"	5"	10013885	2,374	4	10 lbs.
3.5" x 1.125"	3"	8"	10013639	5,219	6	30 lbs.
4" x 2.5"	3"	8"	72344	2,220	4	24 lbs.

\*This label has notches on the left side. Printable area is 3.5" x 0.875".





SEE MORE.  
DO MORE.

# Multipurpose

## General

### Z-Select 4000D

A direct thermal, bright white coated paper label with an all-temp permanent acrylic adhesive

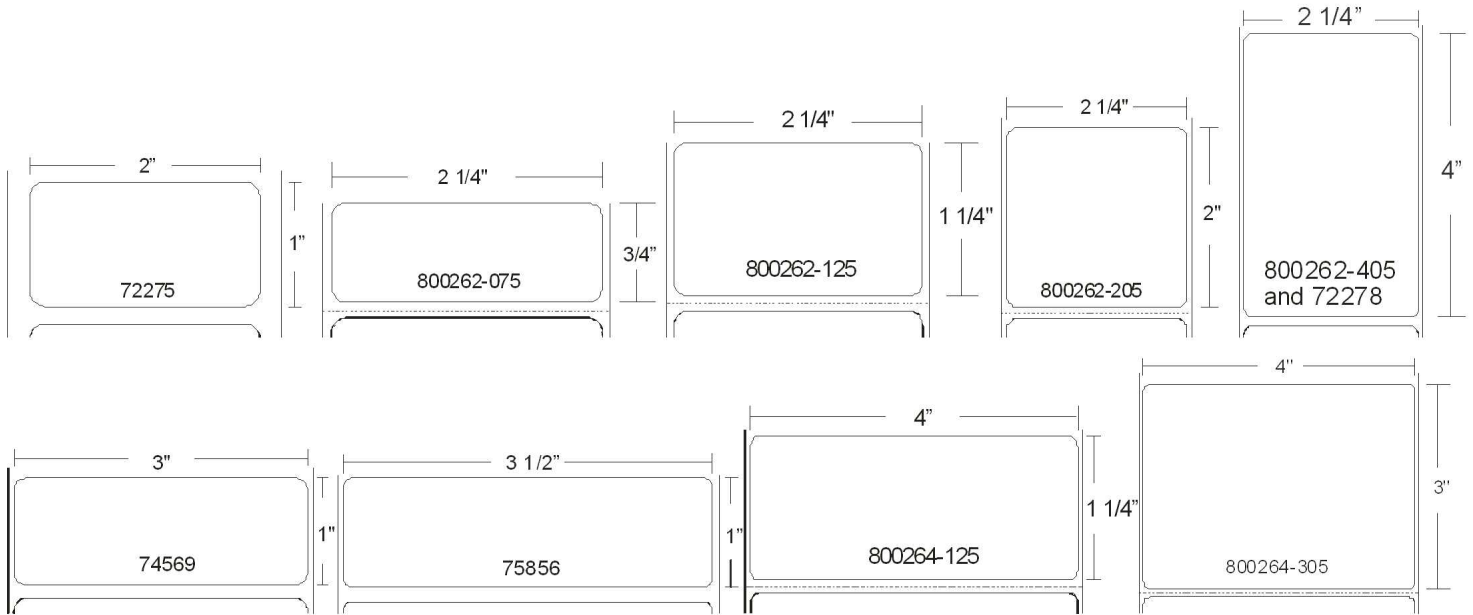

Size (inches)	ID	OD	PartNumber	Quantity Per Roll	Rolls Per Carton	Carton Weight
2" x 1"	3"	8"	72275	4,620	8	22 lbs.
2.25" x 0.75"	1"	5"	10015340	3,315	12	20 lbs.
2.25" x 1.25"	1"	5"	10015341	2,100	12	20 lbs.
2.25" x 2"	1"	5"	10015342	1,370	12	20 lbs.
2.25" x 4"	1"	5"	10015343	700	12	20 lbs.
2.25" x 4"	3"	8"	72278	1,260	8	25 lbs.
3" x 1"	3"	8"	74569	5,120	6	24 lbs.
3.5" x 1"	3"	8"	75856	5,120	6	29 lbs.
4" x 1.25"	1"	5"	10015349	2,100	12	28 lbs.
4" x 3"	1"	5"	10015344	930	12	30 lbs.



SEE MORE.  
DO MORE.

# Multipurpose

## General

### Z-Perform 2000D Floodcoated

A coated direct thermal paper label with an all-temp permanent acrylic adhesive

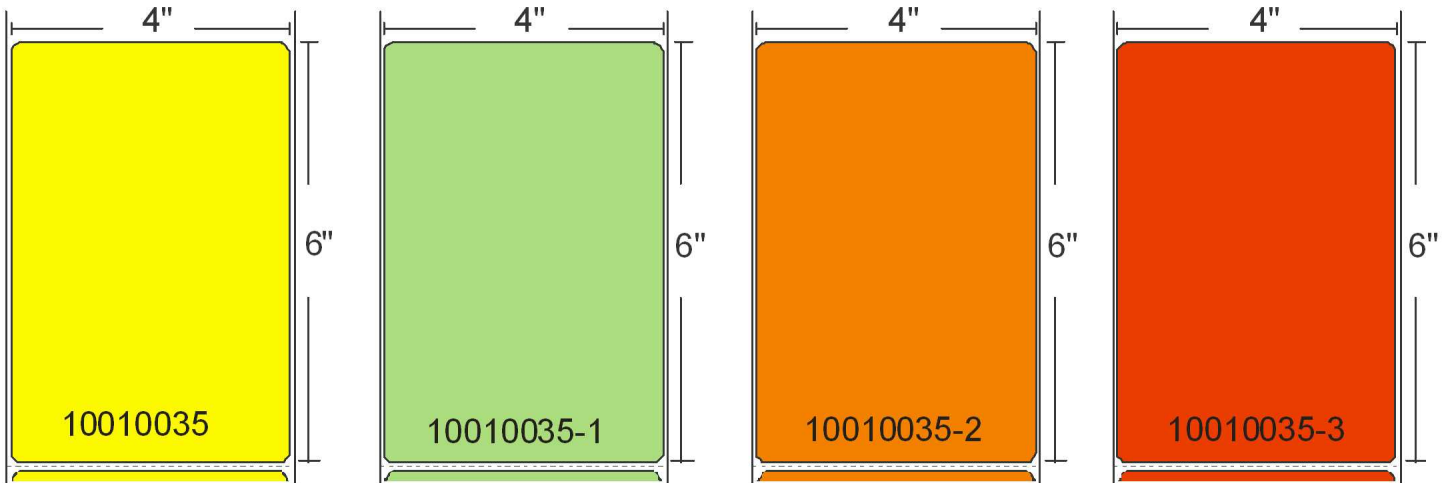

Size (inches)	ID	OD	PartNumber	Color	Quantity Per Roll	Rolls Per Carton	Carton Weight
4" x 6"	1"	5"	10010035	Yellow	430	6	12 lbs.
4" x 6"	1"	5"	10010035-1	Green	430	6	12 lbs.
4" x 6"	1"	5"	10010035-2	Orange	430	6	12 lbs.
4" x 6"	1"	5"	10010035-3	Red	430	6	12 lbs.



SEE MORE.  
DO MORE.

# Multipurpose

## General

### Z-Perform 2000D

A white, coated direct thermal paper label with an all-temp permanent acrylic adhesive

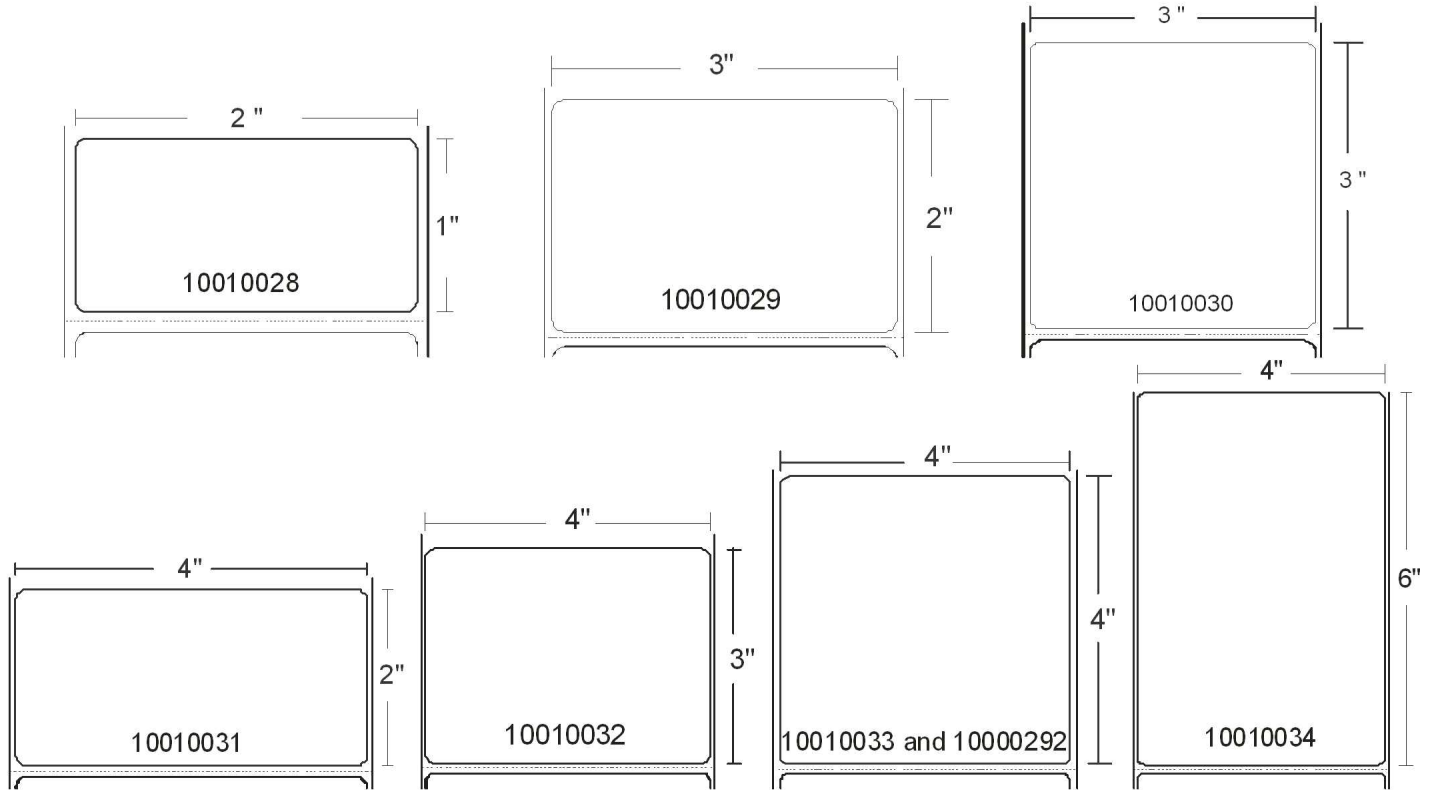

Size (inches)	ID	OD	PartNumber	Quantity Per Roll	Rolls Per Carton	Carton Weight
2" x 1"	1"	5"	10010028	2,340	6	10 lbs
3" x 2"	1"	5"	10010029	1,240	6	11 lbs.
3" x 3"	1"	5"	10010030	840	6	11 lbs.
4" x 2"	1"	5"	10010031	1,240	6	12 lbs.
4" x 3"	1"	5"	10010032	840	6	12 lbs.
4" x 4"	1"	5"	10010033	640	6	12 lbs.
4" x 4"	3"	8"	10000292	1,500	4	27 lbs.
4" x 6"	1"	5"	10010034	430	6	12 lbs.



SEE MORE.  
DO MORE.

# Specialty

## Radiology

### Z-Select 4000D

A direct thermal, bright white coated paper label with an all-temp permanent acrylic adhesive

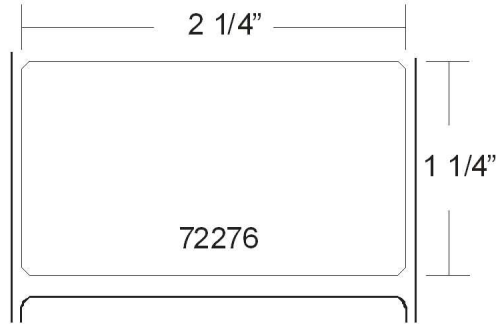

Size (inches)	ID	OD	PartNumber	Quantity Per Roll	Rolls Per Carton	Carton Weight
2.25" x 1.25"	3"	8"	72276	3,770	8	24 lbs.

## Sterilization

### Z-Ultimate 3000T White

A pearl white, gloss polyester thermal transfer label with a high performance permanent acrylic adhesive

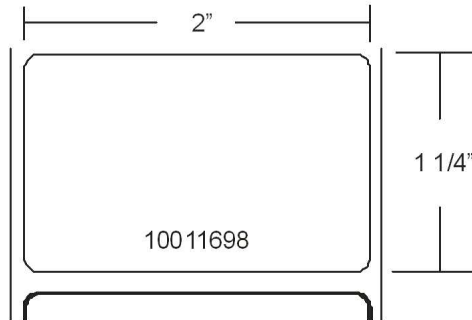

Size (inches)	ID	OD	PartNumber	Quantity Per Roll	Rolls Per Carton	Carton Weight	Ribbon
2" x 1.25"	3"	8"	10011698	4,270	4	10 lbs.	05095BK06045



SEE MORE.  
DO MORE.

# Specialty

## Asset Tracking

### PolyPro 4000T

A Kimdura® polypropylene label with a permanent acrylic adhesive

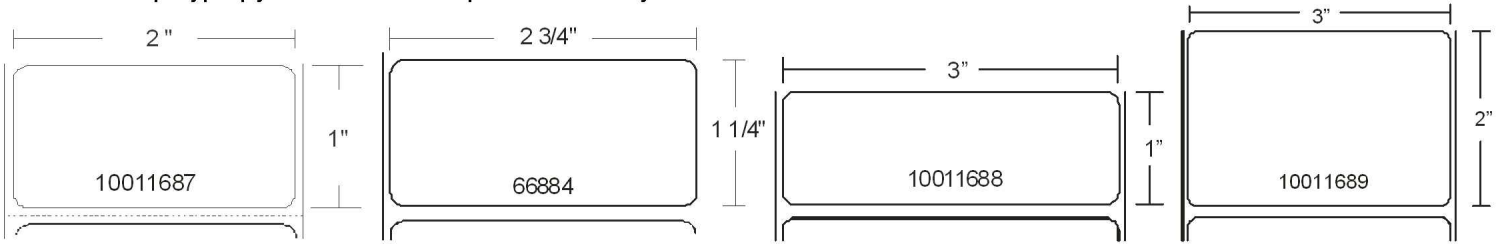

Size (inches)	ID	OD	PartNumber	Quantity Per Roll	Rolls Per Carton	Carton Weight	Ribbon
2" x 1"	3"	8"	10014716	3,940	4	10 lbs.	03200BK06045
2.75" x 1.25"	3"	8"	10014717	3,210	4	28 lbs.	03200BK08045
3" x 1"	3"	8"	10011688	4,350	4	20 lbs.	03200BK08045
3" x 2"	3"	8"	10011689	2,230	4	20 lbs.	03200BK08045



SEE MORE.  
DO MORE.

# Wristbanding

## HC100 Wristband Cartridges

### Z-Band Comfort Kit

Direct thermal, white, soft, flexible polypropylene wristband with a permanent acrylic adhesive paper tab for securement.

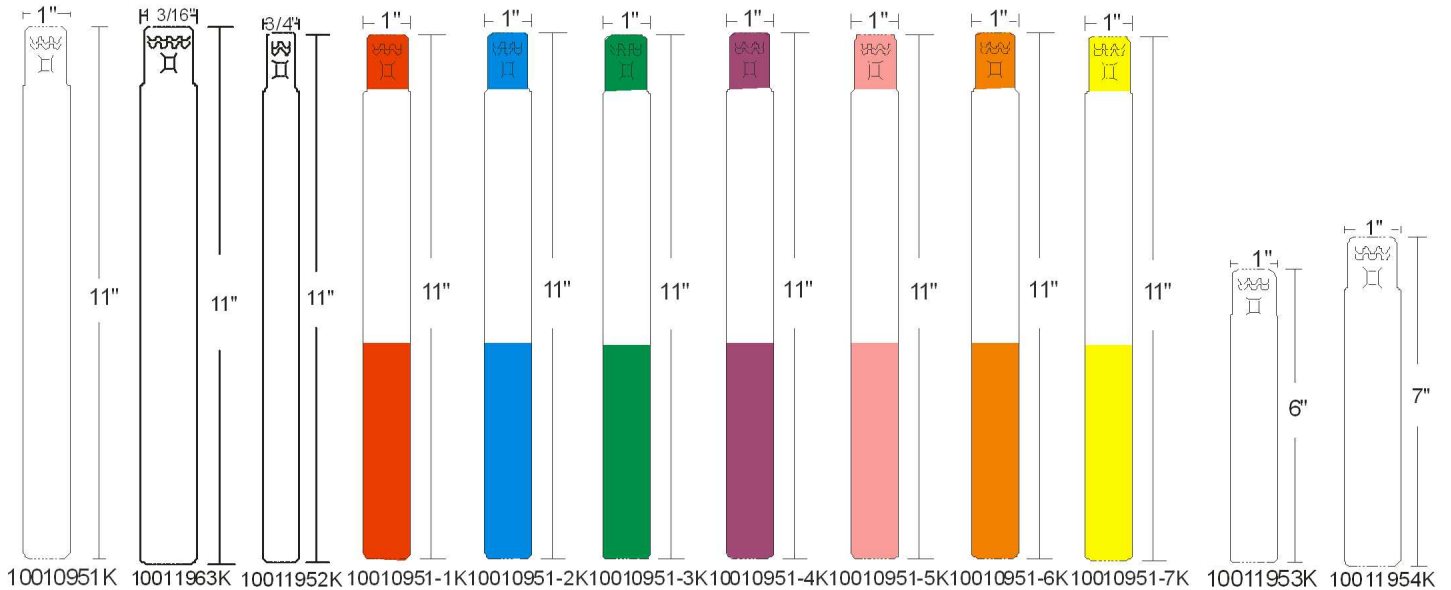

Size (inches)	Color	PartNumber	Quantity Per Roll	Rolls Per Carton	Carton Weight
1" x 11"	White	10010951K	300	6	6 lbs.
1.875" x 11"	White	10011963K	300	6	6 lbs.
0.75" x 11"	White	10011952K	300	6	6 lbs.
1" x 11"	Red	10010951-1K	300	6	6 lbs.
1" x 11"	Blue	10010951-2K	300	6	6 lbs.
1" x 11"	Green	10010951-3K	300	6	6 lbs.
1" x 11"	Purple	10010951-4K	300	6	6 lbs.
1" x 11"	Pink	10010951-5K	300	6	6 lbs.
1" x 11"	Orange	10010951-6K	300	6	6 lbs.
1" x 11"	Yellow	10010951-7K	300	6	6 lbs.
1" x 6"	White	10011953K	600	6	6 lbs.
1" x 7"	White	10011954K	500	6	6 lbs.

Must be ordered in carton quantities. Each part number represents 1 carton.



SEE MORE.  
DO MORE.

# Wristbanding

## HC100 Wristband Cartridges

### Z-Band Direct Kit

A direct thermal white polypropylene wristband with an adhesive paper tab for securement that is located in an easy-to-load cartridge for the HC100 printer.

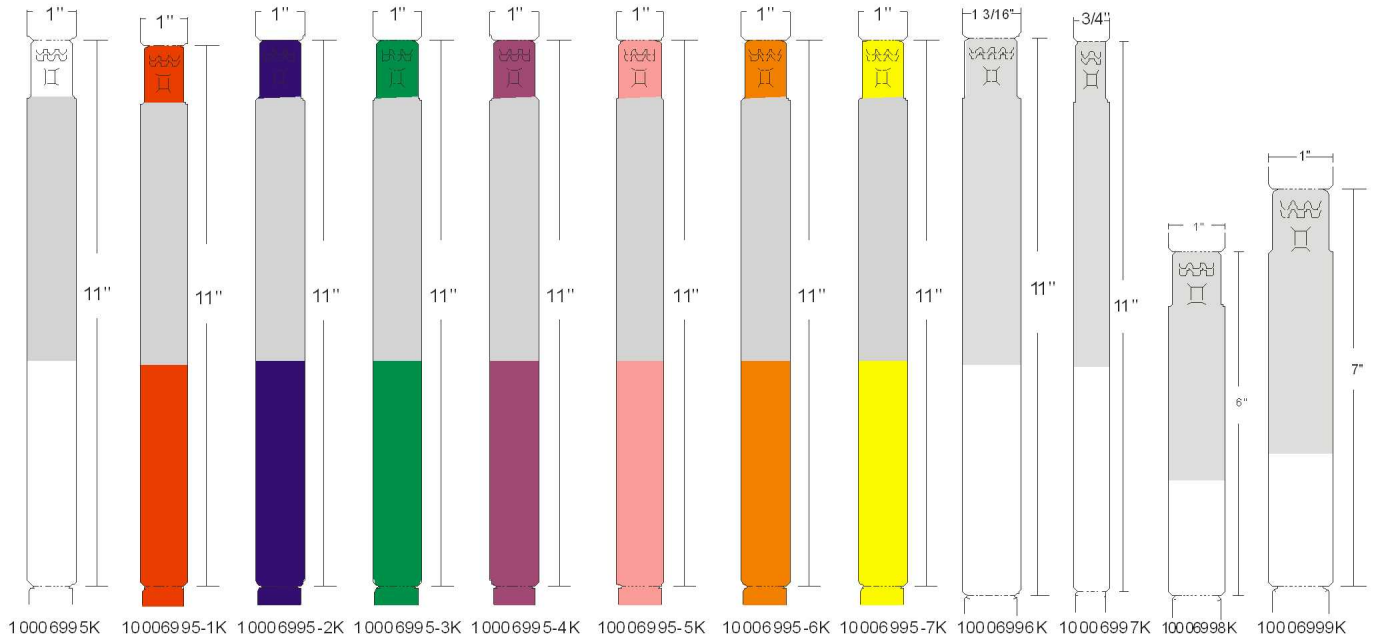

Size (inches)	Color	PartNumber	Quantity Per Roll	Rolls Per Carton	Carton Weight
0.75" x 11"	White	10006997K	200	6	6 lbs.
1" x 11"	White	10006995K	200	6	6 lbs.
1" x 11"	Red	10006995-1K	200	6	6 lbs.
1" x 11"	Blue	10006995-2K	200	6	6 lbs.
1" x 11"	Green	10006995-3K	200	6	6 lbs.
1" x 11"	Purple	10006995-4K	200	6	6 lbs.
1" x 11"	Pink	10006995-5K	200	6	6 lbs.
1" x 11"	Orange	10006995-6K	200	6	6 lbs.
1" x 11"	Yellow	10006995-7K	200	6	6 lbs.
1.1875" x 11"	White	10006996K	200	6	6 lbs.
1" x 6"	White	10006998K	350	6	6 lbs.
1" x 7"	White	10006999K	300	6	6 lbs.

Must be ordered in carton quantities. Each part number represents 1 carton.



SEE MORE.  
DO MORE.

# Wristbanding

## HC100 Wristband Cartridges

### Soft Infant Z-Band Direct Kit

A direct thermal white polypropylene wristband with soft nylon lining with and a permanent acrylic adhesive paper tab for securement that is located in an easy-to-load cartridge for the HC100 printer.

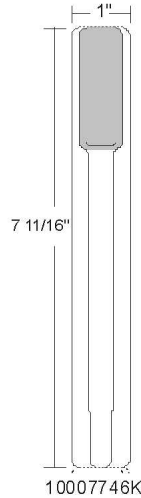

Soft Infant band with 2.062" printable area.  
Narrow adhesive tail loops through to attach.

Size (inches)	Color	PartNumber	Quantity Per Roll	Rolls Per Carton	Carton Weight
1" x 7.6875"	White	10007746K^^	275	6	6 lbs.

Must be ordered in carton quantities. Each part number represents 1 carton.





SEE MORE.  
DO MORE.

# Wristbanding

## HC100 Wristband Cartridges

### Z-Band QuickClip Kit

A direct thermal white polypropylene wristband with a permanent acrylic adhesive paper tab for securement that is located in an easy-to-load cartridge for the HC100 printer.

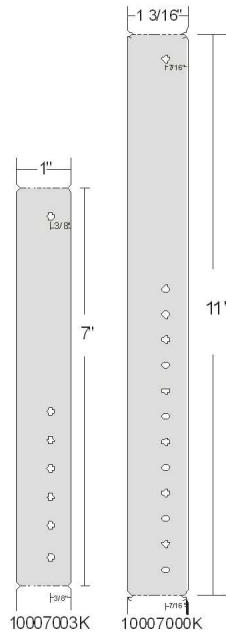

Size (inches)	Color	PartNumber	Quantity Per Roll	Rolls Per Carton	Carton Weight
1.1875" x 11"	White	10007000K*	260	4	6 lbs.
1" x 7"	White	10007003K^	390	3	6 lbs.

^(1 x 7) QuickClip: Includes 3 wristband cartridges and 1,450 white clips. Color clips sold separately.

\*(1.1875 x 11) QuickClip: Includes 4 wristband cartridges and 1,160 white clips. Color clips sold separately.

Must be ordered in carton quantities. Each part number represents 1 carton.



SEE MORE.  
DO MORE.

# Wristbanding

## Z-Band Direct

### Z-Band Direct Wristbands

A direct thermal white polypropylene wristband with a permanent acrylic adhesive paper tab for securement

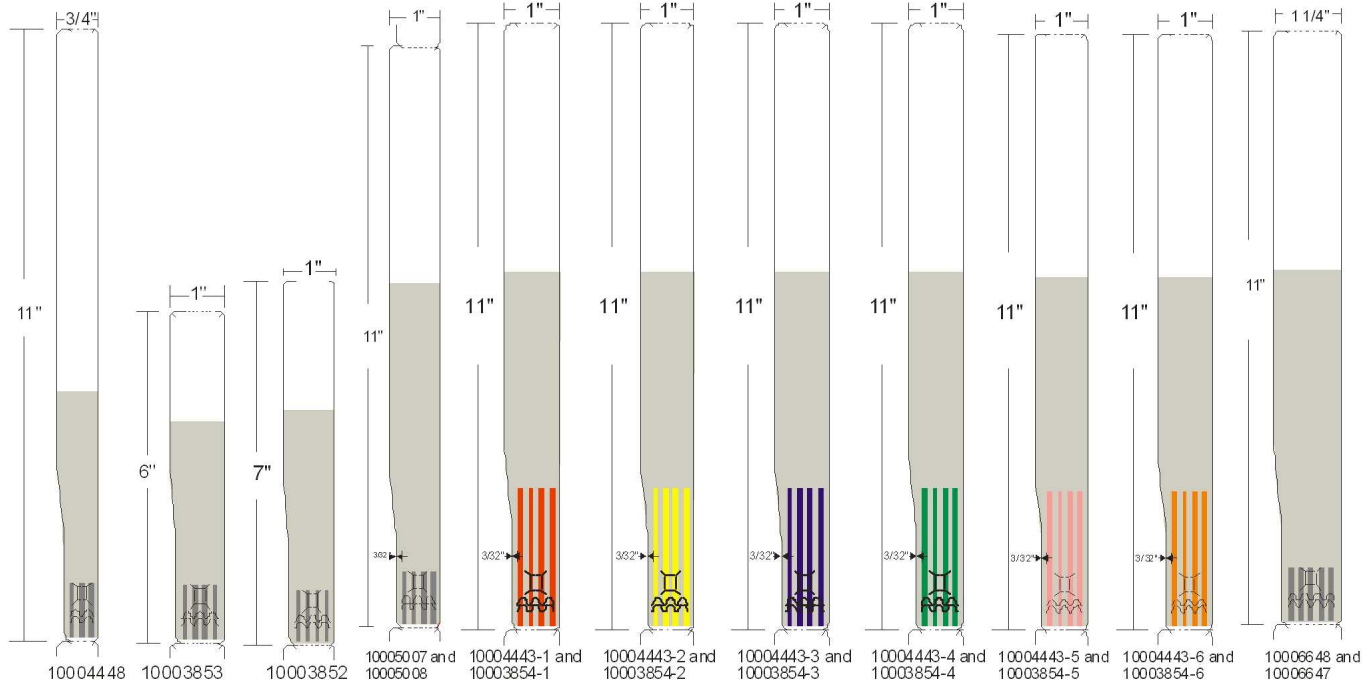

Size (inches)	ID	OD	PartNumber	Color	Quantity Per Roll	Rolls Per Carton	Carton Weight
0.75" x 11"	1"	5"	10004448	White	200	6	4.8 lbs.
1" x 11"	1"	5"	10005008	White	200	6	4.8 lbs.
1" x 11"	3"	8"	10005007	White	450	6	9 lbs.
1" x 11"	1"	5"	10004443-1	Red	200	6	4.8 lbs.
1" x 11"	3"	8"	10003854-1	Red	450	6	9 lbs.
1" x 11"	1"	5"	10004443-2	Yellow	200	6	4.8 lbs.
1" x 11"	3"	8"	10003854-2	Yellow	450	6	9 lbs.
1" x 11"	1"	5"	10004443-3	Blue	200	6	4.8 lbs.
1" x 11"	3"	8"	10003854-3	Blue	450	6	9 lbs.
1" x 11"	1"	5"	10004443-4	Green	200	6	4.8 lbs.
1" x 11"	3"	8"	10003854-4	Green	450	6	9 lbs.
1" x 11"	1"	5"	10004443-5	Pink	200	6	4.8 lbs.
1" x 11"	3"	8"	10003854-5	Pink	450	6	9 lbs.
1" x 11"	1"	5"	10004443-6	Orange	200	6	4.8 lbs.
1" x 11"	3"	8"	10003854-6	Orange	450	6	9 lbs.
1.25" x 11"	1"	5"	10006647	White	200	6	4.8 lbs.
1.25" x 11"	3"	8"	10006648	White	450	6	9 lbs.
1" x 6"	1"	5"	10003853	White	350	6	4.8 lbs.
1" x 7"	1"	5"	10003852	White	300	6	4.8 lbs.



SEE MORE.  
DO MORE.

# Wristbanding

## Quick Clip

### Z-Band Quick Clip Kit

Direct thermal polypropylene wristband with secure clip closures.

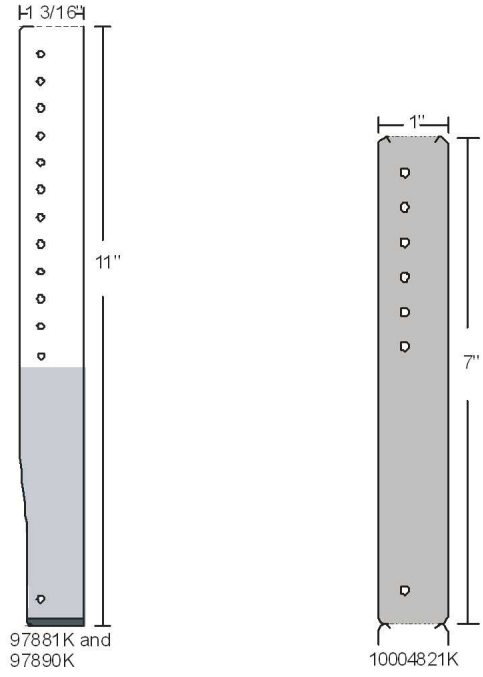

Size (inches)	ID	OD	PartNumber	Quantity Per Roll	Rolls Per Carton	Carton Weight
1" x 7"	1"	5"	10004821K <sup>^</sup>	390	6	10 lbs.
1.1875" x 11"	1"	5"	97881K <sup>*</sup>	260	6	11 lbs.
1.1875" x 11"	3"	8"	97890K <sup>**</sup>	550	6	11 lbs.

<sup>^</sup> (1 x 7) Includes 6 rolls of perforated wristbands and 2,610 white clips. Color clips sold separately.  
<sup>\*</sup> (1.1875 x 11) Includes 6 rolls of perforated wristbands and 1,740 white clips. Color clips sold separately.  
<sup>\*\*</sup> (1.1875 x 11) Includes 6 rolls of perforated wristbands and 3,480 white clips. Color clips sold separately.

### Color Clips for Z-Band Quick Clip Wristbands

PartNumber	Color	Quantity Per Pack
97032-Pink	Pink	275
97032-Red	Red	275
97032-Blue	Blue	275
97032-Green	Green	275
97032-Yellow	Yellow	275
97032-Purple	Purple	275



SEE MORE.  
DO MORE.

# Wristbanding

## Infant

### Soft Infant Wristband

A direct thermal white polypropylene wristband with soft nylon lining with a t-shaped adjustable design, flat surface print area and a permanent acrylic adhesive paper tab for securement .

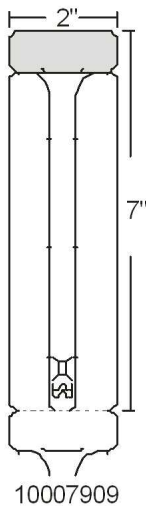

Size (inches)	Quantity Per Roll	PartNumber	Rolls Per Carton	Carton Weight
2" x 7"	275	10007909	6	6 lbs.



SEE MORE.  
DO MORE.

## Ribbons

Ribbon Part #	Width (inches)	Width (mm)	Quantity Per Carton	Weight	Printer Type
<b>2000 WAX</b>					
02000BK06045	2.36"	60mm	24	23 lbs.	Tabletop
<b>3200 WAX/RESIN</b>					
03200GS11007	4.30"	110mm	12	2.8 lbs.	Desktop
03200BK06045	2.36"	60mm	6	23 lbs.	Tabletop
03200BK08045	3.15"	80mm	6	24 lbs.	Tabletop
03200BK11045	4.33"	110mm	6	32 lbs.	Tabletop
<b>5095 RESIN</b>					
05095BK06045	2.36"	60mm	6	23 lbs.	Tabletop
<b>IMAGE LOCK</b>					
74943	4.30"	110mm	12	3 lbs.	Desktop

**MINIMUM ORDER QUANTITY FOR ALL RIBBONS IS 1 CARTON.**



# CLEAR IDENTIFICATION. SAFER PATIENTS.

Zebra gives a digital voice to patients,  
medications and workflows.

Zebra's HC100™ thermal printer and Z-Band® wristbands deliver the benefits you need:

- Durable bar code images that scan accurately
- Easy-to-load cartridges
- Less maintenance and fewer IT help desk calls
- ADT software compatibility

Combining the reliable HC100 and Z-Band cartridge, Zebra's HC100 Patient I.D. Solution is your safe and cost-effective choice. Learn more about protecting patient safety at [zebra.com/healthcare](http://zebra.com/healthcare).



**SEE MORE. DO MORE.**



[www.L-TronDirect.com](http://www.L-TronDirect.com)

800-830-9523

[info@L-Tron.com](mailto:info@L-Tron.com)

596 Fishers Station Dr | Victor, NY | 14564 | Suite 1 A

[www.L-Tron.com](http://www.L-Tron.com)

